

Fiber Unit

# E32-ETS / EDS Series

E32-ETS / EDS Series

## Flat square shape for easy mounting

- Flat and space saving shape fits in narrow spaces
- Easy mounting and optical axis alignment
- No mounting bracket necessary, just fixing it with two screws
- Flexible fibers with 1 mm bending radius
- Strong Aluminium housing for rough ambient conditions



## Application

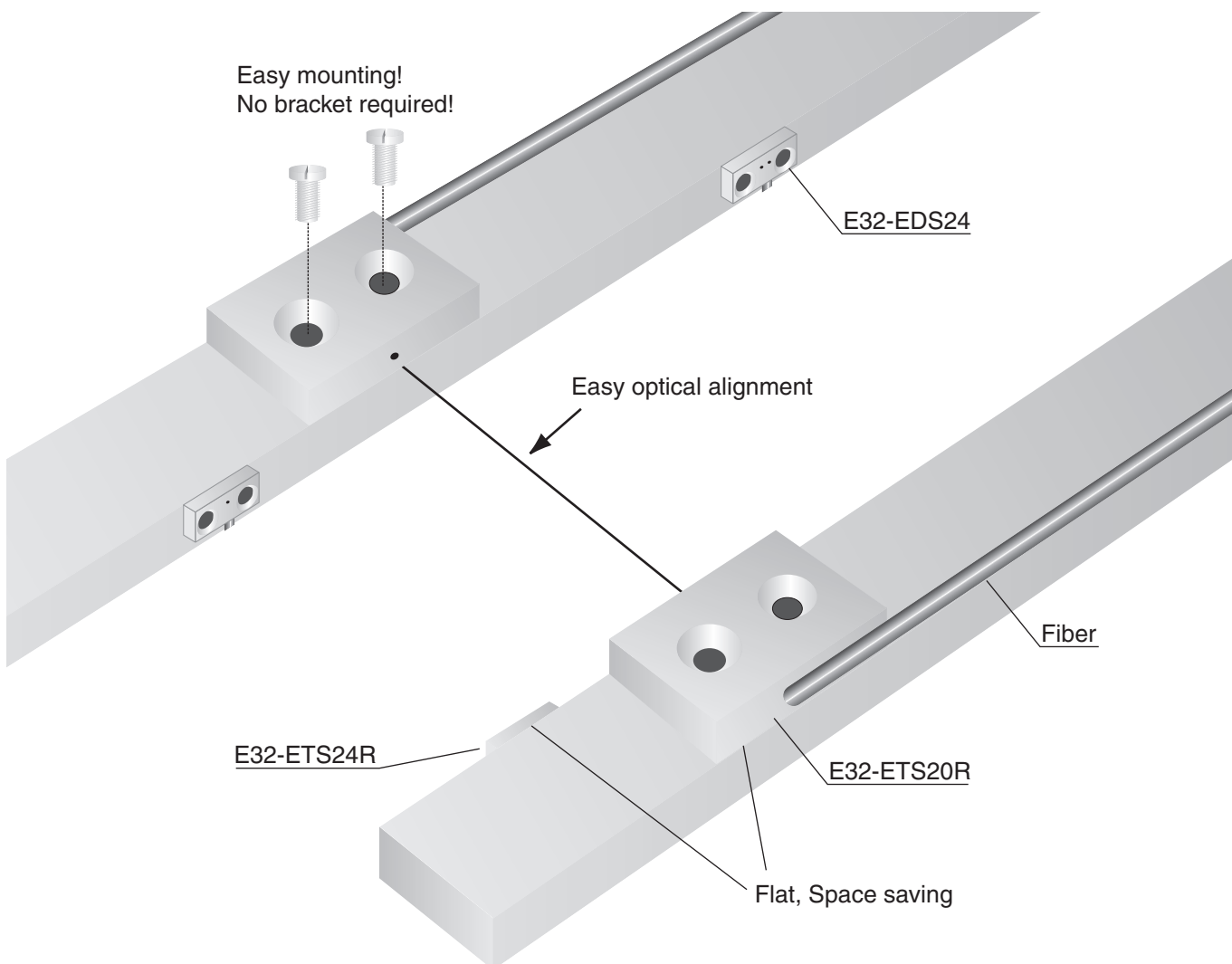

Ordering Information

Sensors

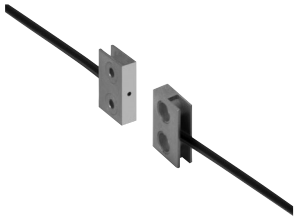
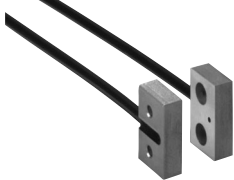
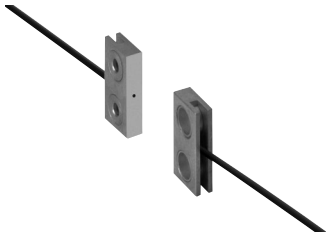
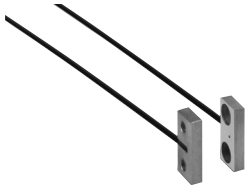
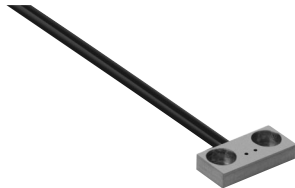
Sensor Type	Product Code	Shape
Through Beam	E32-ETS10R 2M	
Through Beam, Side View	E32-ETS14R 2M	
Through Beam	E32-ETS20R 2M	
Through Beam, Side View	E32-ETS24R 2M	
Diffuse Reflection, Side View	E32-EDS24R 2M	

## Amplifier Overview

### Digital Amplifier

[Amplifier Units](#)

[Amplifier Units with Cables](#)

Item		Appearance	Functions	Model	
				NPN output	PNP output
Standard models			---	E3X-DA11-S	E3X-DA41-S
Mark-detecting models	Green LED		---	E3X-DAG11-S	E3X-DAG41-S
	Blue LED		---	E3X-DAB11-S	E3X-DAB41-S
Advanced models	Twin-output models		Area output, self-diagnosis, differential operation	E3X-DA11TW-S	E3X-DA41TW-S
	External-input models		Remote setting, counter, differential operation	E3X-DA11RM-S	E3X-DA41RM-S

### Amplifier Units with Connectors

Item		Appearance	Functions	Model	
				NPN output	PNP output
Standard models			---	E3X-DA6-S	E3X-DA8-S
Mark-detecting models	Green LED		---	E3X-DAG6-S	E3X-DAG8-S
	Blue LED		---	E3X-DAB6-S	E3X-DAB8-S
Advanced models	Twin-output models		Area output, self-diagnosis, differential operation	E3X-DA6TW-S	E3X-DA8TW-S
	External-input models		Remote setting, counter, differential operation	E3X-DA6RM-S	E3X-DA8RM-S

### Dual Channel Amplifier

[Amplifier Units](#)

[Amplifier Units with Cables](#)



Item	Appearance	Functions	Model	
			NPN output	PNP output
2-channel models		AND/OR output	E3X-MDA11	E3X-MDA41

### Amplifier Units with Connectors

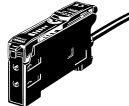

Item	Appearance	Functions	Model	
			NPN output	PNP output
2-channel models		AND/OR output	E3X-MDA6	E3X-MDA8

## Manual Amplifier

### Amplifier Units with Cables

Item	Shape	Control output	Model	
			NPN output	PNP output
Standard models		ON/OFF output	E3X-NA11	E3X-NA41
High-speed detection			E3X-NA11F	E3X-NA41F
Mark-detecting models			E3X-NAG11	E3X-NAG41
Water-resistant models			E3X-NA11V	E3X-NA41V

### Amplifier Units with Connectors

Item	Shape	Applicable Connector (order separately)		Control output	Model	
					NPN output	PNP output
Standard models		Master	E3X-CN11	ON/OFF output	E3X-NA6	E3X-NA8
		Slave	E3X-CN12			
Water-resistant models (M8 Connector)		XS3F-M421-40□-A XS3F-M422-40□-A			E3X-NA14V	E3X-NA44V

## Performance

### Sensing Distance

Amplifier	Mode	E32-ETS10R 2m	E32-ETS14R 2M	E32-ETS20R 2M	E32-ETS24R 2M	E32-EDS24R 2M
E3X-DA-N	Super long distance mode	700 mm	580 mm	150 mm	130 mm	45 mm
	Standard mode	560 mm	460 mm	120 mm	110 mm	35 mm
	Super high speed mode	200 mm	170 mm	40 mm	40 mm	10 mm
	Super long distance mode	480 mm	430 mm	160 mm	160 mm	70 mm
E3X-MDA	Standard mode	370 mm	330 mm	120 mm	120 mm	50 mm
	Super high speed mode	140 mm	130 mm	50 mm	50 mm	20 mm
	Super long distance mode	720 mm	630 mm	250 mm	240 mm	100 mm
E3X-DA-S	Standard mode	560 mm	480 mm	190 mm	180 mm	60 mm
	Super high speed mode	140 mm	125 mm	50 mm	45 mm	20 mm
E3X-NA41	Standard mode	420 mm	280 mm	100 mm	50 mm	17 mm
E3X-NAG41	Standard mode	100 mm	80 mm	25 mm	10 mm	2 mm
E3X-NA41F	Standard mode	140 mm	100 mm	30 mm	15 mm	4 mm

Specifications

Type / Application		Aluminium Square Shape					
		Through beam types				Reflective type	
Item	Model	Operation Storage	E32-ETS10R	E32-ETS14R	E32-ETS20R	E32-ETS24R	E32-EDS24R
Ambient temperature		- 40°C to 70°C with no icing or condensation					
Ambient humidity		Operating: 35% to 95% RH, Storage: 35% to 95% with no icing or condensation					
Permission bending radius		1 mm					
Fiber sheat material		Black Polyehylene (PE)					
Fiber core		Acrylic resin (PMMA)					
Fiber diameter		2.2 mm	2.2 mm	1 mm	1 mm	1 mm	
Protective structure		IEC 60529 IP 67					
Material sensorhead		Aluminium (AL)					

E32-ETS / EDS Series

Dimensions

E32-ETS10R

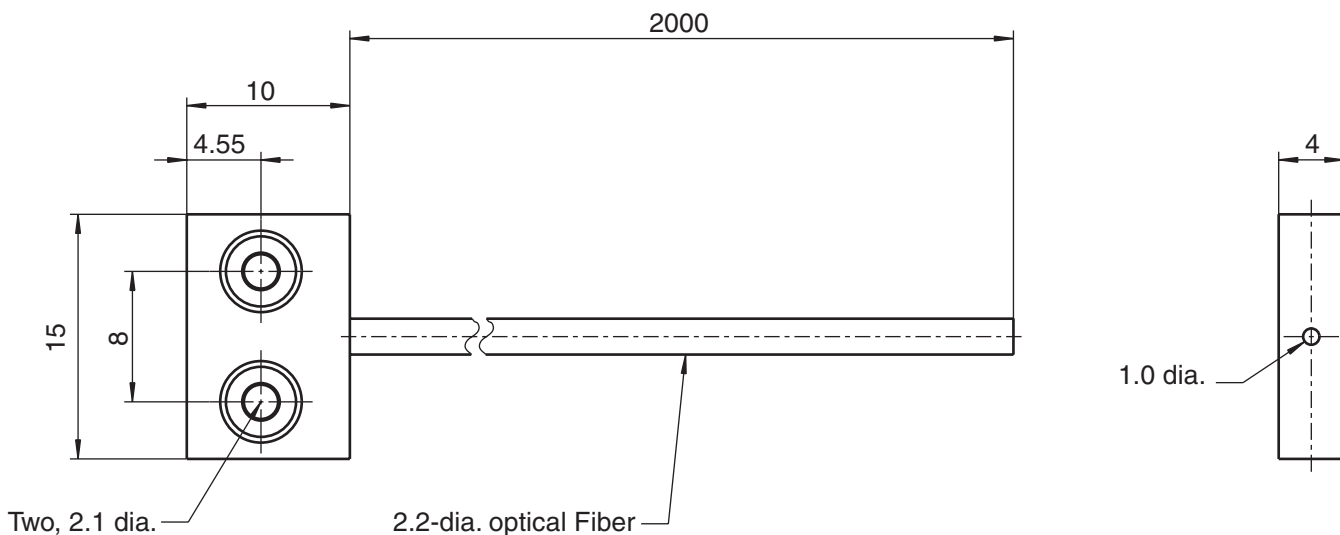

E32-ETS14R

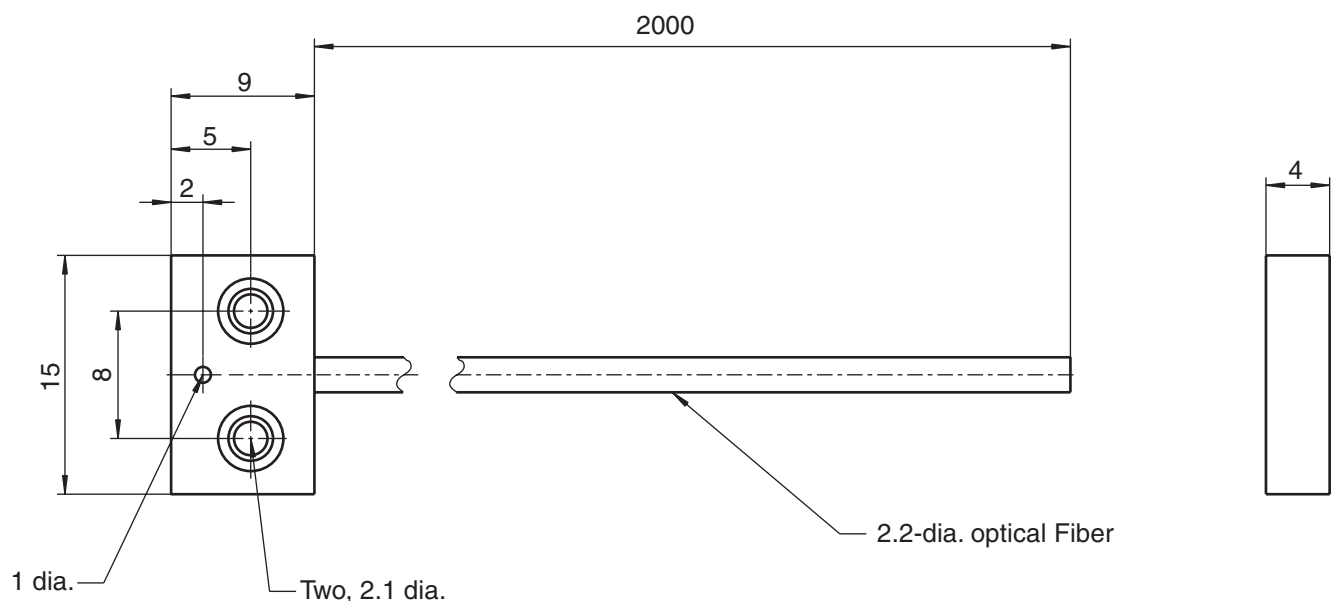

E32-ETS20R

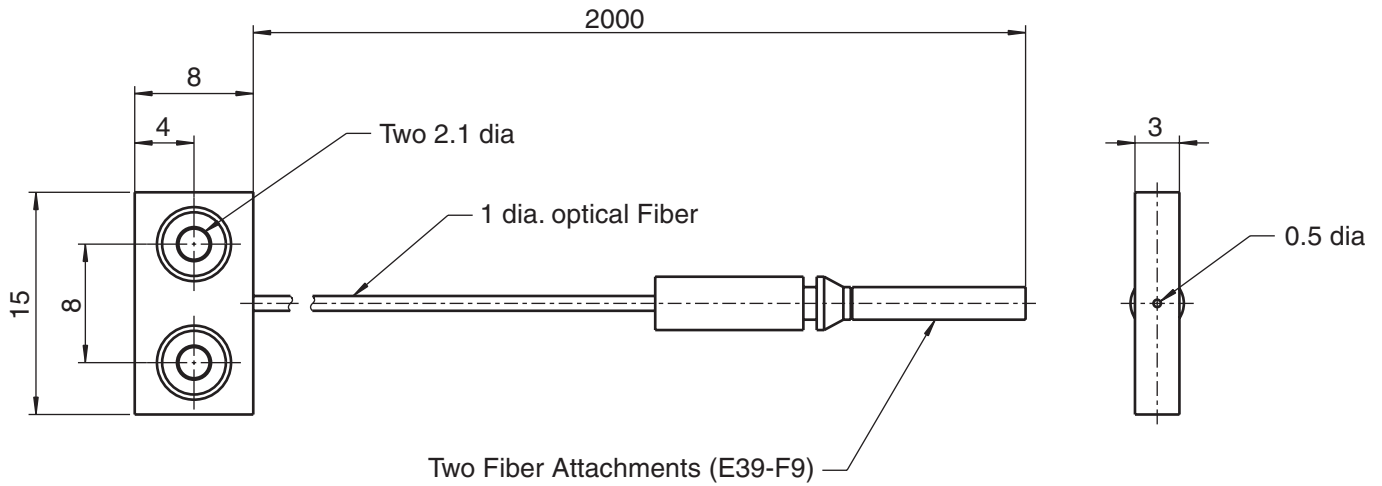

E32-ETS24R

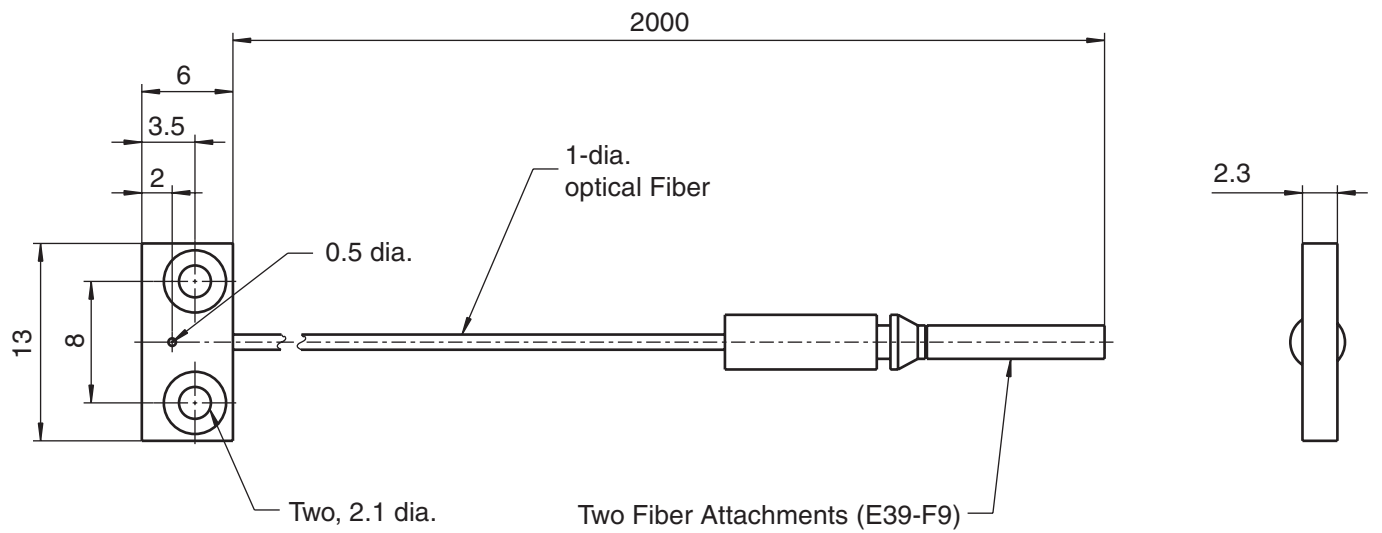

E32-EDS24R

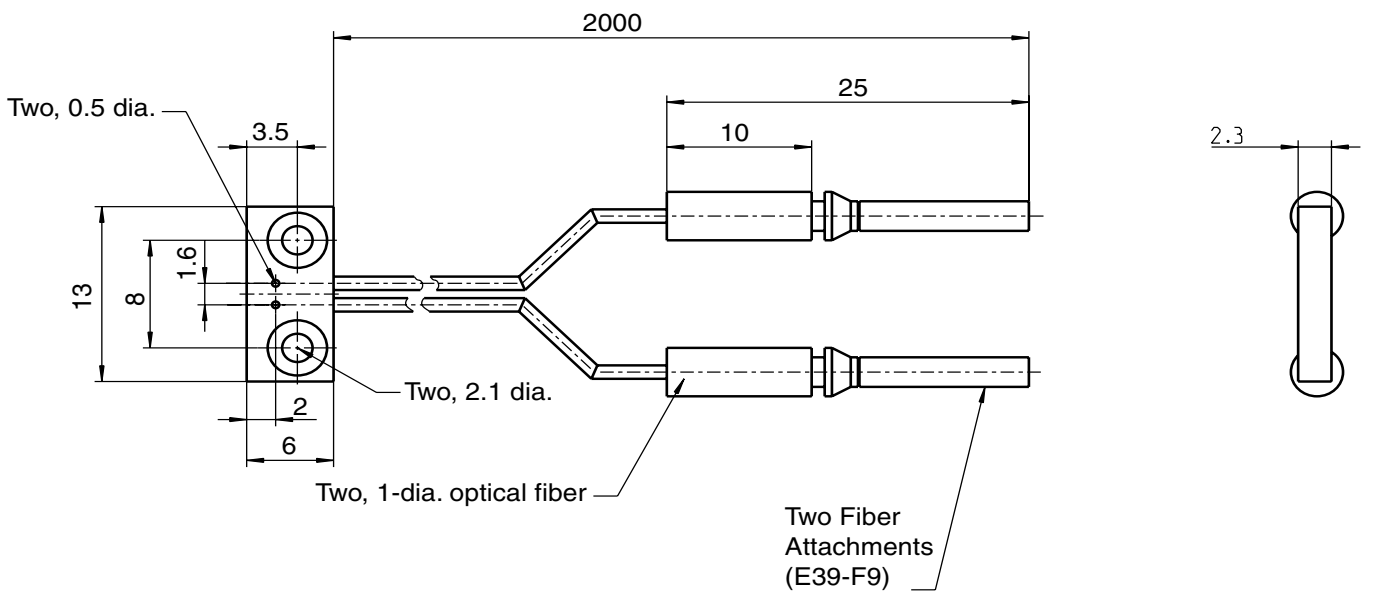

## Precautions

### Fiber Units

#### Installation

#### Fiber Connection and Disconnection

The E3X Amplifier Unit has a lock button. Connect or disconnect the fibers to or from the E3X Amplifier Unit using the following procedures:

##### 1. Connection

Open the protective cover, insert the fibers according to the fiber insertion marks on the side of the Amplifier Unit, and lower the lock button.

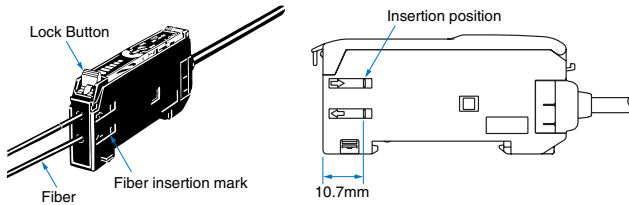

##### 2. Disconnection

Remove the protective cover and raise the lock button to pull out the fiber.

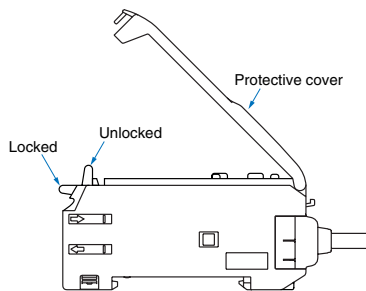

**Note: To maintain the fiber properties, confirm that the lock is released before removing the fiber.**

##### 3. Precautions for Fiber Connection/Disconnection

Be sure to lock or unlock the lock button within an ambient temperature range between -10°C and 40°C.

#### Cutting Fiber

- Insert a fiber into the Fiber Cutter and determine the length of the fiber to be cut.
- Press down the Fiber Cutter in a single stroke to cut the fiber.
- The cutting holes cannot be used twice. If the same hole is used twice, the cutting face of the fiber will be rough and the sensing distance will be reduced. Always use an unused hole.

- Cut a thin fiber as follows:

①	An attachment is temporarily fitted to a thin fiber before shipment.	
②	Secure the attachment after adjusting the position of it in the direction indicated by the arrow.	
③	Insert the fiber to be cut into the E39-F4.	
④	Finished state (proper cutting state)	

#### Connection

- Do not strain the fiber unit, e.g. do not apply tensile or compression force. (Within 0.98 Nm to 18 Nm) Use special care since the fiber is thin.
- The bending radius of the fiber unit should exceed the admissible bending radius given in "Type/standard price" and "Ratings/performance".
- Do not bend the edge of the fiber units (excluding the E32-T□R and E32-D□R).

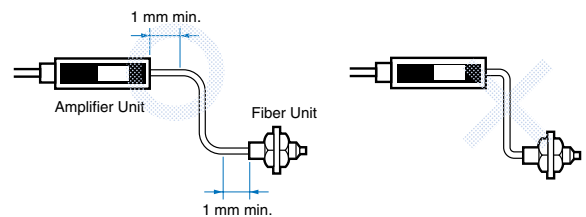

- Do not apply excess force on the fiber units.

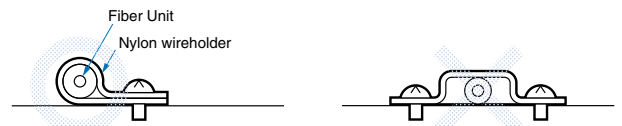

- The fiber head could be break from excessive vibration. To prevent this, the following is applied:

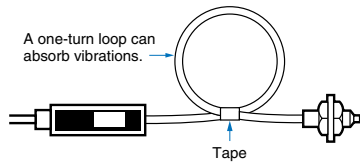

**E39-F11 Sleeve Bender**

- The bending radius of the stainless steel tube should be as large as possible. The smaller the bending radius becomes, the shorter the sensing distance will be.
- Insert the tip of the stainless steel tube to the sleeve bender and bend the stainless steel tube slowly along the curve of the sleeve bender (refer to the figure).

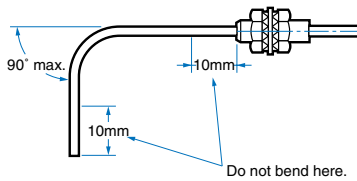
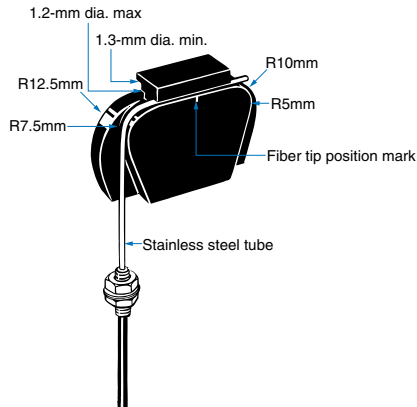

**Accessories**

**Use of E39-R3 Reflector**

- When using an adhesive tape on the rear face, apply it after washing off oil, dust, etc. with detergent from the place of application. The reflector cannot be installed if there remains oil, etc.
- The E39-R3 cannot be used in places where it is exposed to oil or chemicals.

**E39-F10 Fiber Connector**

Fit the connector in the following procedure.

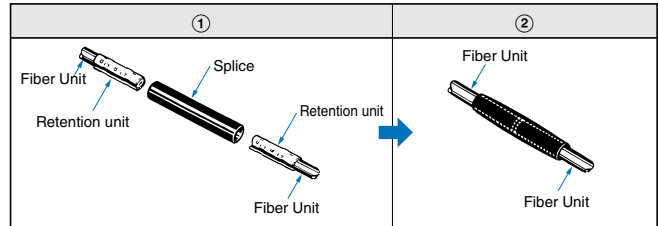

- The fiber units should be as close as possible when they are connected. Sensing distance will be reduced by approximately 25% when fibers are connected.

Only 2.2 mm dia. fibers can be connected.

ALL DIMENSIONS SHOWN ARE IN MILLIMETERS.  
 To convert millimeters into inches, multiply by 0.03937. To convert grams into ounces, multiply by 0.03527.