

Distance setting laser photoelectric sensor

# F3C-AL

- 700 mm max setting distance
- small visible Laser light spot for simple adjustment



## Features

### Clear red spot ensures easy setting.

With its wide setting range 170 to 700 mm, F3C-AL is compatible with standard conveyors. In the setting distance of 700 mm, the distance can be set easily with a 1.5x4 mm red spot.

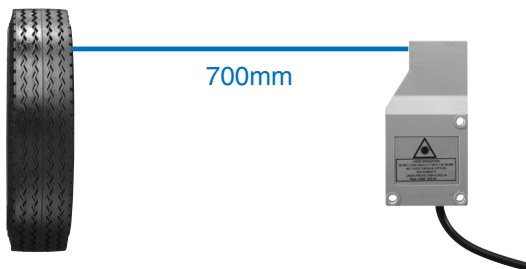

### Secure detection of shiny surface

Ensures stable detection of a 45-degree shiny surface. Detection of pouches, laminated packages or like minimizes setup change time.

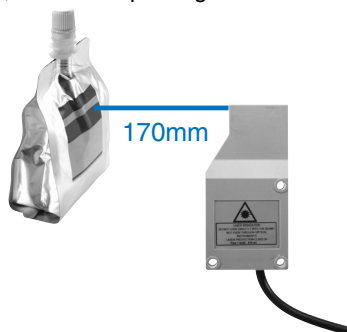

### Unaffected by a shiny background.

Insensitive to shiny objects in the background, the Sensor can be installed in any place.

### Small Black/White error:

2% (Setting distance 300 mm),  
8% max. (Setting distance 500 mm)

A little black/white error saves adjustment time during setup change.

### Full hysteresis detection range 0.5% max. (for white paper)

### 6-turn adjuster ensures ease of adjustment.

Application

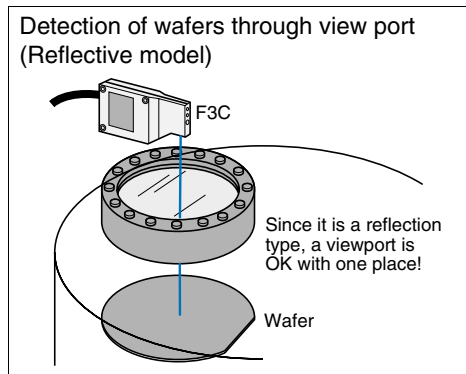
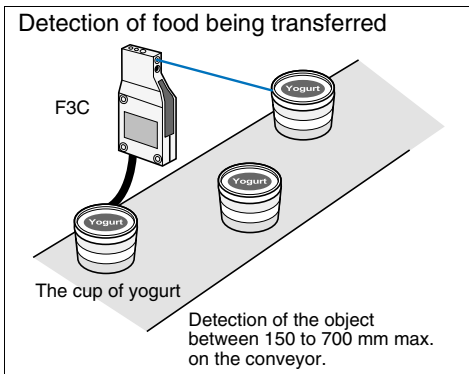

Ordering Information

Sensors

Red light

Shape	Connection method	Sensing/Setting range	Operating mode	Model	
				NPN output	PNP output
	Pre-wired with M12-connector	120 170 700 mm Setting range Sensing distance 120 to 700 mm	Light-ON/Dark-ON cable connection selectable	F3C-AL14-M1J	F3C-AL44-M1J

Accessories (Order Separately)

Mounting Brackets

Shape	Model	Quantity
	E39-L40	1

Sensor I/O Connectors

Cable specifications	Shape	Cable type	Model
Standard cable	Straight type	2 m	XS2F-D421-D80-A
		5 m	XS2F-D421-G80-A
	L type	2 m	XS2F-D422-D80-A
		5 m	XS2F-D422-G80-A
Robot cable (for vibration resistance)	Straight type	2 m	XS2F-D421-D80-R
		5 m	XS2F-D421-G80-R
	L type	2 m	XS2F-D422-D80-R
		5 m	XS2F-D422-G80-R

Rating/Performance

Item	Model	F3C-AL14-M1J	F3C-AL44-M1J
Sensing		120 to 700 mm (White paper 100 x 100 mm) (Setting distance 700 mm)	
Setting distance range		170 to 700 mm (White paper, 90% remission, 100 x 100 mm) 170 to 560 mm (White paper, 6% remission, 100 x 100 mm)	
Black-/white-error		20% max. (of setting distance, 90%/6% remission)	
Spot Diameter		1.5 x 4 mm (Setting distance 700 mm)	
Light source		Pulsed red light semiconductor laser Class II: < 1mWeff. / 670 nm / 5% duty cycle (Impulse time 60 μs, Period time: 1.2 ms)	
Power supply voltage		10 to 30 VDC [ripple (p-p) 10% included]	
Current consumption		30 mA max.	
Control output		Load supply voltage 30 VDC max., load current 150 mA max. (residual voltage: 2 V max.) NPN open collector output type, Light-ON/Dark-ON cable connection selectable	Load supply voltage 30 VDC max., load current 150 mA max. (residual voltage: 2 V max.) PNP open collector output type, Light-ON/Dark-ON cable connection selectable
Protective circuits		Reverse polarity protection, output short-circuit protection, mutual interference prevention	
Response time		Operation and reset: 10 ms max.	
Sensitivity adjustment		6-turn adjuster	
Ambient illuminance		Incandescent lamp/Sunlight: 5,000 lux max.	
Ambient temperature		Operating: 0°C to 50°C, Storage: -25°C to 60°C (with no icing or condensation)	
Ambient humidity		Operating/Storage: 35% to 85%RH (with no condensation)	
Insulation resistance		20 M min. at 500 VDC	
Vibration resistance		10 to 55 Hz double amplitude 1.5 mm or 300 m/s <sup>2</sup> for 2 h in each of X, Y, Z directions	
Shock resistance		Destruction: 500 m/s <sup>2</sup> for 3 times each in X, Y, and Z directions	
Protective structure		IEC Standard IP40	
Connection method		M12 connector joint type (standard cable length 200 mm) / 4 x 0.34 mm <sup>2</sup> (PVC)	
Weight (packed state)		Approx. 80 g	
Material	Case	ABS	
	Lens	Acrylics (PMMA)	
Accessories		Adjusting screwdriver, Laser warning label, instruction manual	

## Characteristic data (typical)

### Parallel operating range

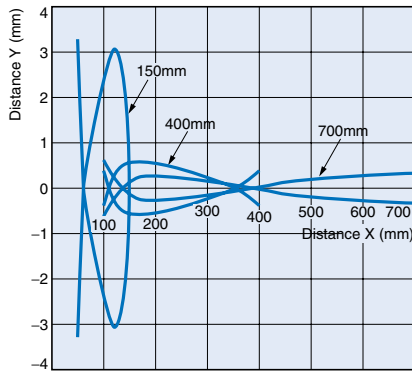

### Black/White error

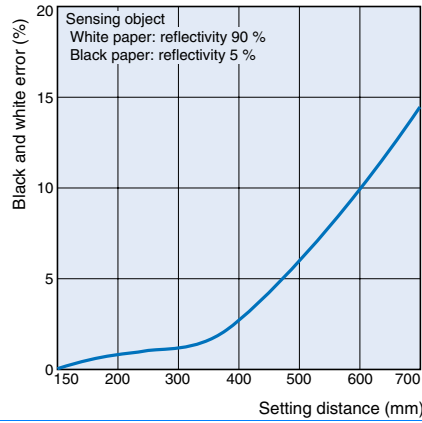

### Short distance characteristic chart

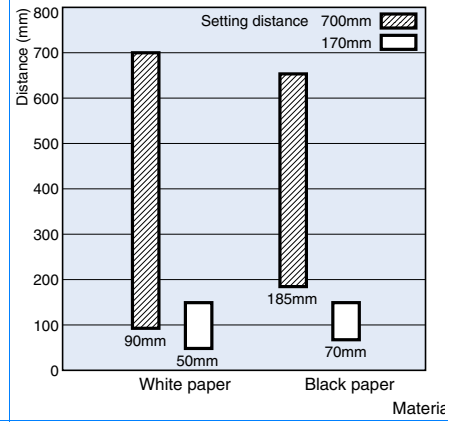

### Hysteresis

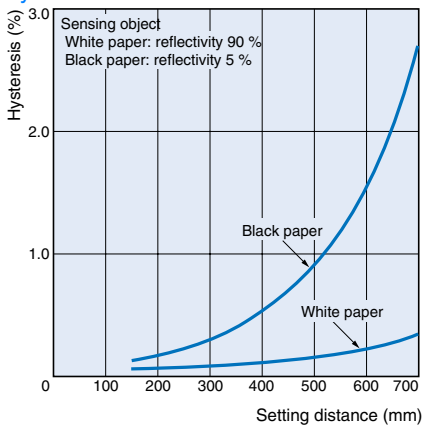

# Output Circuit Diagram

## NPN output

Model	Operating status of output transistor	Timing chart	Mode selection	Output circuit
F3C-AL14-M1J	Light ON		Connect ② to ① or disconnect ②.	<p>Connector Pin Arrangement</p>
	Dark ON		Connect ② to ③.	<p>Connector Pin Arrangement</p>

## PNP output

Model	Operating status of output transistor	Timing chart	Mode selection	Output circuit
F3C-AL44-M1J	Light ON		Connect ② to ① or disconnect ②.	<p>Connector Pin Arrangement</p>
	Dark ON		Connect ② to ③.	<p>Connector Pin Arrangement</p>

### Connectors (Sensor I/O connectors)

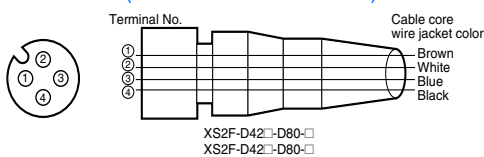

Class	Wire, outer	Connector	Application
For DC	Brown	①	Power supply (+V)
	White	②	Operation switching
	Blue	③	Power supply (0 V)
	Black	④	Output

## Sensitivity Adjustment

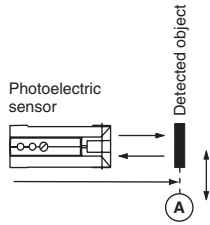
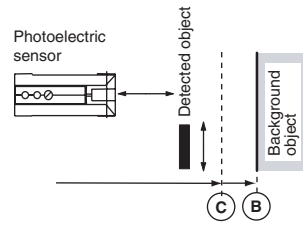
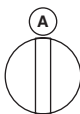
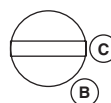
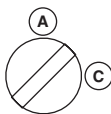
Item	Position A	Position B and C	Setting
Adjustment procedure	Place the detected object at the desired location and turn the LIGHT indicator (red) lights. This is position A	Background object Remove the detected object and turn the adjustment knob clockwise until the LIGHT indicator (red) lights. This is the position B. Then turn the adjustment knob counterclockwise until the LIGHT indicator (red) goes out. This is position C. No Background object The maximum adjustment setting is used as position C.	Set the adjustment to halfway between A and C. Confirm that the STAB indicator (green) remains lit both with the detected object present and not present. If the STAB indicator does not remain lit, review the detection method to enable stable operation.
Detecting condition			
Status of distance setting knob			
Indicators	OFF <input type="radio"/> STABILITY (green) ON <input checked="" type="radio"/> LIGHT (red)	OFF <input type="radio"/> STABILITY (green) OFF <input type="radio"/> LIGHT (red)	ON <input checked="" type="radio"/> STABILITY (green) OFF <input type="radio"/> LIGHT (red)

### Special hints

#### Recommended adjustment

To assure stable working conditions the green stability LED should be always turned on.

The green LED displays two stability conditions:

1. Output stable ON (red LED on)
2. Output stable OFF (red LED off)

Best performance can be achieved if the sensing object is located closer than -10 % of the setting distance or the shiny background is fixed +10 % behind the switching position.

Precautions

Safety Precaution



**Laser beam!**

Laser protection class 2  
Do not look into the laser beam.  
Pay attention to the accident prevention regulations and the laser protection class.

**Visible laser emission!**

Avoid any indirect or direct radiation of reflected or emitted laser light!

Laser safety

The laser safeguards have been stipulated for laser equipment in and outside Japan. The following gives brief description for use in Japan.

The JIS C6802 Standard stipulates safety preventives that must be taken by the user according to the laser product class. (The outline is given in the following table.)

User's Requirements

Item	Class		Class 3A	Class 3B		Class 4
	Class 1	Class 2		3B*	3B	
Using remote interlock		Not required			Connect the remote interlock of the laser beam to the emergency main interlock, the interlock of the room, or the interlock of the door.	
Key control		Not required			Do not keep the key in the lock when the laser beam is not used.	
Beam breaker or attenuator		Not required			Used to protect people from accidental radiation by the laser beam.	
Warning sign		Not required			Post a proper warning sign on the door to the room where laser beam equipment is installed.	
Beam path	Not required	The laser beam must be terminated and, as a rule, must be enclosed. If the laser beam is exposed, the vertical height of the beam must not be the same as that of the eyes.				
Mirror reflection		Not required			Appropriate optical elements must be securely attached and you must be able to control the optical elements during laser radiation.	
Eye protect		Not required			Use eye protectors except in special, specified locations.	
Protection clothes		Not required	Wear protection clothes if exposure of the skin to the laser beam may exceed the MPE of the skin.			
Training		Not required	The laser system must be operated by only properly trained people.			

\* 5 mW or less in the visible range

Classification of F3C

Class 2
---------

Handle laser equipment in accordance with the following precautions.

- Do not look into the beam.
- Do not disassemble the product. Doing so will release the laser beam to wander around.

Please obtain or prepare the "Laser product safety standards" on your own responsibility.

Labels related to laser

The following warning label is applied to the side face of the photoelectric sensor.

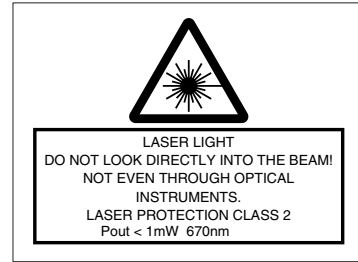

For use in Japan, change the above label for the one that meets the JIS Standards.

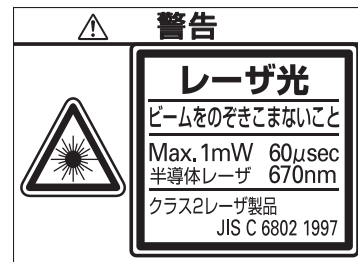

Handling Instructions

F3C radiates a visible-light laser. Do not look into it directly. Use F3C so that the light path of the laser beam is terminated. If there is a mirror-smooth reflector in the light path, confine the beam away from the reflected light path. If F3C must be used with the light path open, avoid placing the light path on the eye level.

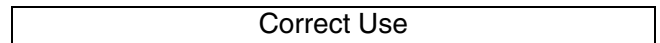

Design

Power Reset Time

The Photoelectric Sensor is ready to sense an object in 300 ms after power-on. Therefore, use it 300 ms after power-on. If the load and Sensor are connected to different power supplies, always switch on power for the Sensor first.

Wiring Considerations

Load short-circuit protection

- The F3C-AL has load short-circuit protection. If a load short-circuit or like has occurred, the output turns OFF. Therefore, recheck the wiring and switch power on again. This resets the short-circuit protection circuit. Load short-circuit protection is activated when a current of 1.8 times or more of the rated load current flows. When using an L load, use the one the inrush current of which is less than 1.8 times of the rated load current.
- Do not use the input power exceeding the rated voltage. Doing so can cause damage.
- Do not shorten the load with the open collector output. Otherwise, damage might be caused.
- Run the wiring of F3C separately from the high voltage and power cables.

- Avoid wiring them together or running them within the same duct. Doing so may get them induced, causing a malfunction or damage.
- For extension of the cable, use a 0.3-mm<sup>2</sup> or more cable and run it within 50 m.

**Mounting**

- Install the photoelectric sensor so that the sun, fluorescent lamp, incandescent lamp or any other strong light will not enter the directional angle range of the sensor.
- If Sensors are installed face-to-face, ensure that no optical axes cross each other. Otherwise, mutual interference may result.
- Use M4 screws to mount the unit.
- When mounting the case tighten it to the torque of 1.2 Nm max.

**Miscellaneous**

**Operating Environment**

- Avoid using the Sensor in a strong disturbance light (e.g. laser beam or arc welding beam) or strong electromagnetic field.

- Depending on their material and/or shape, some objects may not be detected or may be detected with low accuracy. (Mirror-smooth material, transparent material, material of extremely low reflectivity, object smaller than spot diameter)

**Correct operation**

The moving direction of the sensor or object should be preferably along the optical axis of the light beam. Lateral approach is also possible. Movement from the top to the bottom or opposite can cause malfunction and should be avoided.

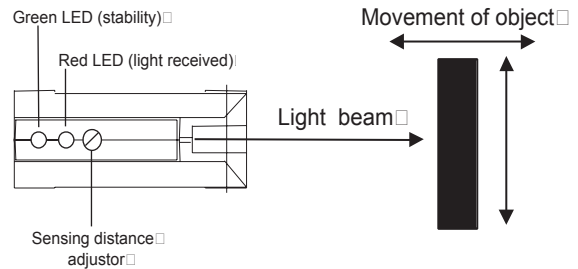

**Dimensions (Unit: mm)**

**Sensors**

F3C-AL14-M1J  
F3C-AL44-M1J

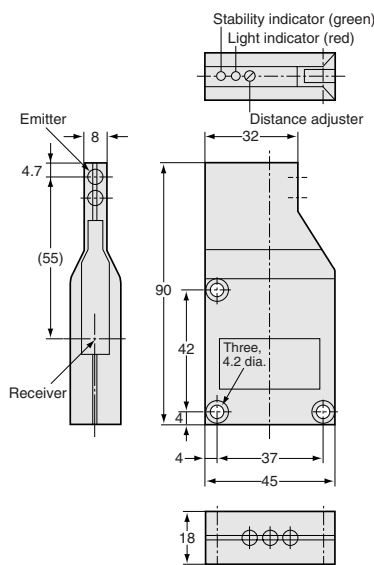

Terminal No.	Specifications
1	+V
2	L-ON/D-ON selection
3	0V
4	Output

Note. L-ON when 1-2 are connected  
D-ON when 2-3 are connected

nyl-insulated round cable of 4 dia.  
4 cores conductor Standard length:  
200 mm

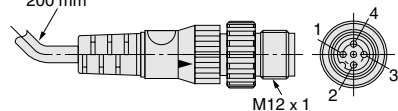

**Accessories (Order Separately)**

**Mounting Brackets**

H-5

ALL DIMENSIONS SHOWN ARE IN MILLIMETERS.  
To convert millimeters into inches, multiply by 0.03937. To convert grams into ounces, multiply by 0.03527.