

Muting Controller for Safety Light Curtain

F3SP-U4P

- High functionality (two independent muting functions, override function, automatic and manual reset).
- Category 2 or 4 depending on safety light curtain.
- Only 45 mm width
- Double output safety relay.
- 6 LED for status and diagnostics.
- Detachable terminals for easy installation.
- Controls 1 or 2 safety light curtains
- TÜV approved

Muting controller for one or two Safety Light Curtain.

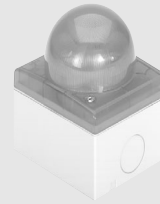
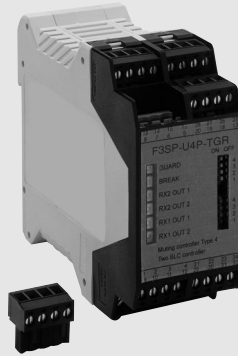

List of Models

Controller

Description	Model
 Muting Controller for Safety Light Curtain F3S-B, F3SN and F3SH	F3SP-U4P-TGR

Accessories

Description	Model
 Muting lamp	F39-A11

Rating / performance

	F3SP-U4P-TGR
Power supply voltage	24 VDC ±10%
Power consumption	420 mA max. (excl. SLC power consumption)
Output contacts	2 NO 2,5 A (protected by fuse)
Indicators	6 LEDs for status and diagnostics.
Enclosure rating	IP20
Terminal	32 screw terminals (1,5 mm ²), detachable blocks with 4 screws each
Response time	≤30 ms
Ambient temperature	Operating: -10 °C +55 °C
Housing material	Plastic, DIN rail mounting
Weight	0,6 kg

F3SP-U4P

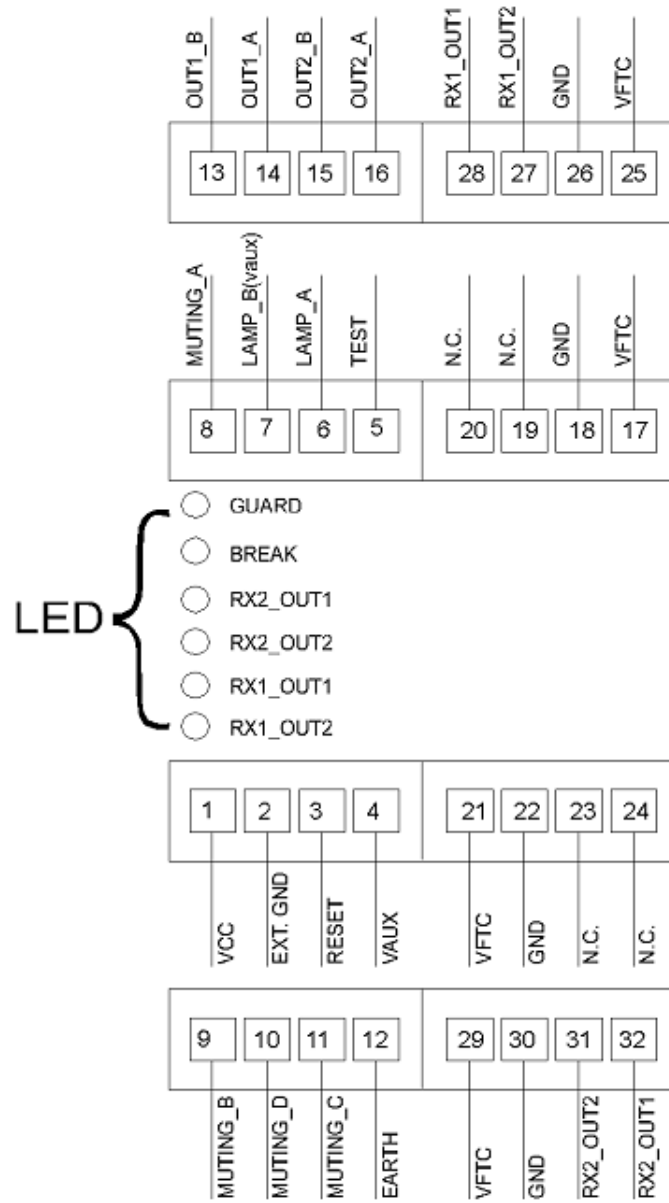

Wiring Example

Control unit F3SP-U4P-TGR in a mixed configuration that allows the use of several OMRON safety light curtains and perimetrical guards.

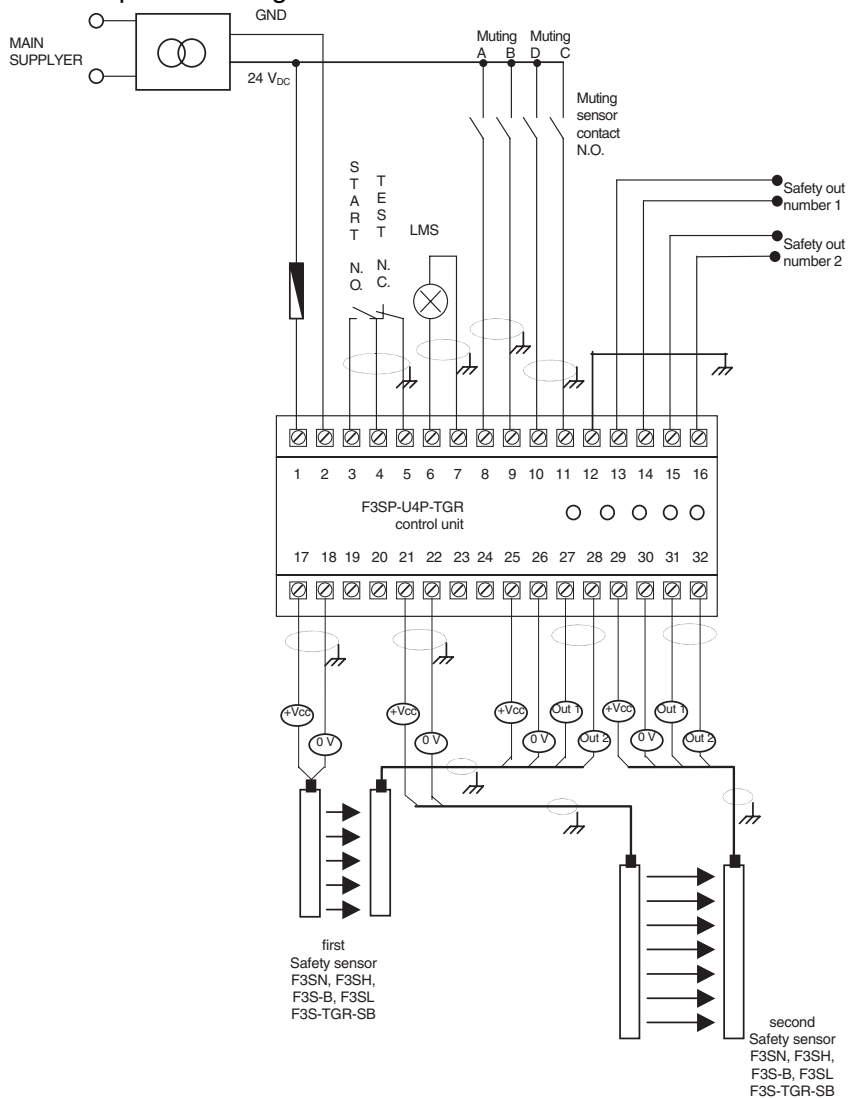

Dimensions

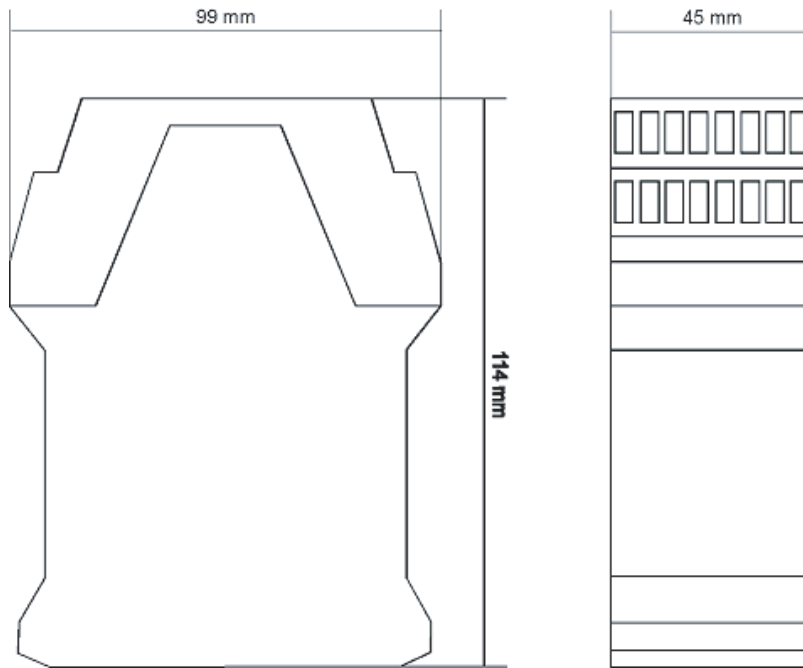

ALL DIMENSIONS SHOWN ARE IN MILLIMETERS.
 To convert millimeters into inches, multiply by 0.03937. To convert grams into ounces, multiply by 0.03527.