

Multi voltage photoelectric sensor in plastic housing with timer function



E3JM

The square sized E3JM family provides 12 to 240 VDC and 24 to 240 VAC power supply voltage, an enhanced sensing distance and a timer function.

- 12 to 240 VDC and 24 to 240 VAC supply voltage
- Relay or solid state relay output
- Timer function

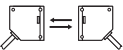

Ordering Information

Sensor type	Sensing distance	Conne- tion method	Timer function	Order code		
				Relay output	DC SSR output	
					minus common	plus common
Through-beam 	10 m	Terminal block (with PG 13.5)	–	E3JM-10M4-G-N	E3JM-10S4-G-N	E3JM-10R4-G-N
			ON or OFF delay 0.1 s to 5 s	E3JM-10M4T-G-N	E3JM-10S4T-G-N	E3JM-10R4T-G-N
Retro-reflective with M.S.R. 	4 m		–	E3JM-R4M4-G	E3JM-R4S4-G	E3JM-R4R4-G
			ON or OFF delay 0.1 s to 5 s	E3JM-R4M4T-G	E3JM-R4S4T-G	E3JM-R4R4T-G
Diffuse-reflective 	700 mm (adjustable)		–	E3JM-DS70M4-G	E3JM-DS70S4-G	E3JM-DS70R4-G
			ON or OFF delay 0.1 s to 5 s	E3JM-DS70M4T-G	E3JM-DS70S4T-G	E3JM-DS70R4T-G

Accessories

Slit

Slit width	Sensing distance	Minimum sensing object (typical)	Model	Quantity	Remarks
1 mm x 20 mm	1.2 m	1 mm dia.	E39-S39	1 Slit each for Emitter and Receiver (2 Slits total)	(Seal-type long slit) Can be used with the Through-beam Model E3JM-10□4(T).

Reflectors

Name	Sensing distance (typical)	Model	Quantity	Remarks
Reflectors	4 m (rated value)	E39-R1	1	Provided with the E3JM-R4□4(T).
Small Reflectors	3.5 m	E39-R3	1	---
Tape Reflectors	1 m (200 mm) (See note 2.)	E39-RS1	1	---
	1.6 m (200 mm) (See note 2.)	E39-RS2	1	
	2 m (200 mm) (See note 2.)	E39-RS3	1	

Note 1. For the complete overview of available reflectors please refer to www.industrial.omron.eu or to the accessory datasheet E26E.
2. Values in brackets are the minimum required distance between the Sensor and Reflector.

Mounting Bracket

Appearance	Model	Quantity	Remarks
	E39-L53	1	Provided with the E3JM

Note: If a Through-beam Model is used, order two Mounting Brackets for the Emitter and Receiver respectively.

Specifications

Ratings/Characteristics

Item	Through-beam		Retro-reflective with M.S.R.		Diffuse-reflective	
	E3JM-10□4	E3JM-10□4T	E3JM-R4□4	E3JM-R4□4T	E3JM-DS70□4	E3JM-DS70□4T
Sensing distance	10 m		4 m (When using E39-R1)		White paper (200 × 200 mm): 700 mm	
Standard sensing object	Opaque: 14.8-mm dia. min.		Opaque: 75-mm dia.min.		---	
Differential travel	---		---		20% max. of sensing distance	
Directional angle	Both Emitter and Receiver 3° to 20°		1° to 5°		---	
Light source (wavelength)	Infrared LED (950 nm)		Red LED (660 nm)		Infrared LED (950 nm)	
Power supply voltage	12 to 240 VDC±10%, ripple (p-p): 10% max. 24 to 240 VAC±10%, 50/60 Hz					
Power consumption	3 W max.		2 W max.			
Control output	Relay output (M Models): SPDT 250 VAC, 3 A max. (cosφ = 1) 5 VDC, 10 mA min. DC SSR output (S, R Models):48 VDC, 100 mA max. (residual voltage: 2 V max.) Light-ON/Dark-ON selectable					
Life expectancy	Mechanical	50,000,000 times min. (switching frequency: 18,000 times/h)				
	Electrical	100,000 times min. (switching frequency: 1,800 times/h)				
Response time	Relay output	Operation or reset: 30 ms max.				
	DC SSR output	Operation or reset: 5 ms max.				
Sensitivity adjustment	---				One-turn adjuster	
Timer function (See note.)	ON-delay/OFF-delay/One-shot delay switch selectable Delay time: 0.1 to 5 s (adjustable), only for E3JM-□□□4T					
Ambient illumination (Receiver side)	Incandescent lamp: 3,000 lx max.					
Ambient temperature	Operating:−25°C to 55°C (with no icing or condensation) Storage:−30°C to 70°C (with no icing or condensation)					
Ambient humidity	Operating:45% to 85% (with no condensation) Storage:35% to 95% (with no condensation)					
Insulation resistance	20 MΩ min. at 500 VDC between current-carrying parts and case					
Dielectric strength	2,000 VAC, 50/60 Hz for 1 min. between current-carrying parts and case					
Vibration resistance	Destruction	10 to 55 Hz, 1.5-mm double amplitude for 2 hours each in X, Y, and Z directions				
	Malfunction	10 to 55 Hz, 1.5-mm double amplitude for 2 hours each in X, Y, and Z directions				
Shock resistance	Destruction	500 m/s ² 3 times each in X, Y, and Z directions				
	Malfunction	100 m/s ² 3 times each in X, Y, and Z directions				
Degree of protection	IEC 60529: IP66					
Connection method	Terminal block					
Indicator	Light indicator (red), power indicator (red)	Operation indicator (red), power indicator (red)	Light indicator (red)	Operation indicator (red)	Light indicator (red)	Operation indicator (red)
Weight (packed state)	Approx. 270 g		Approx. 160 g		Approx. 160 g	
Material	Case	ABS				
	Lens	Methacrylic resin				
	Cover	Polycarbonate				
	Mounting Bracket	Iron				
Accessories	Mounting Bracket (with screw), nut, terminal protection cover, one set of cable connection nuts, reflector (E39-R1: only for retro-reflective models), instruction manual					

Note: The timer cannot be disabled for Models with timer functions (E3JM-□□□4T).

Engineering Data

Parallel Operating Range (Typical)
Through-beam
E3JM-10□4(T)

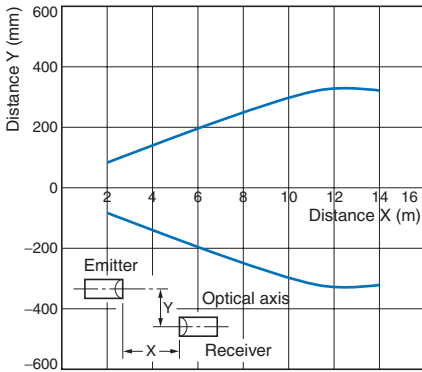

Parallel Operating Range (Typical)
Through-beam
E3JM-10□4(T) with E39-S39 (Slit)

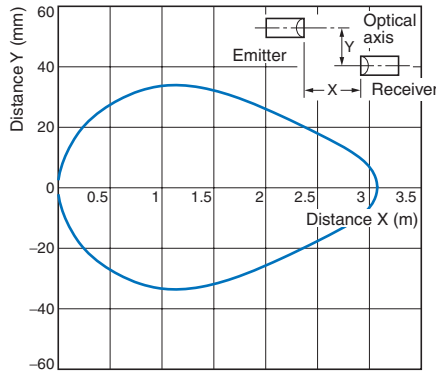

Parallel Operating Range (Typical)
Retro-reflective
E3JM-R4□4(T) (When Using E39-R1)

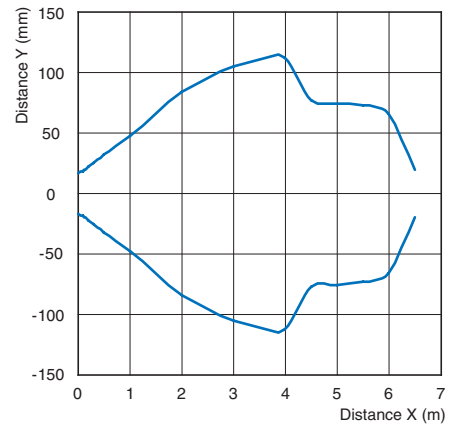

Operating Range (Typical)
Diffuse-reflective
E3JM-DS70□4(T)

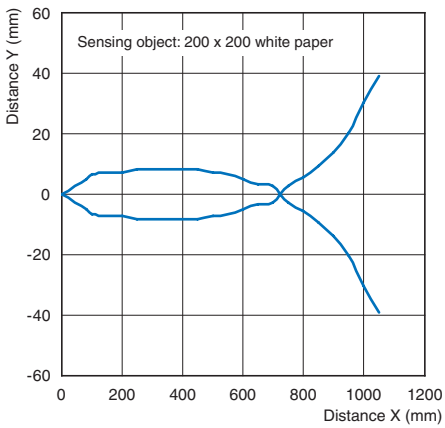

Size of Sensing Object vs. Sensing Distance
Diffuse-reflective
E3JM-DS70□4(T)

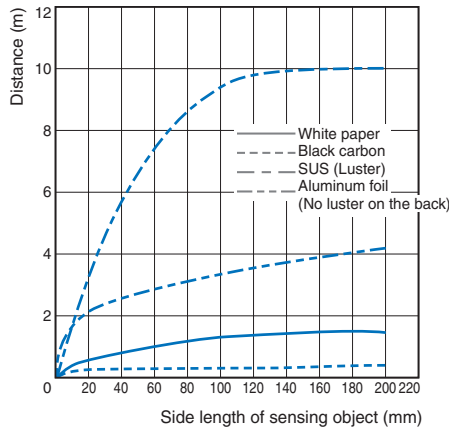

Excess Gain Ratio vs. Set Distance (Typical)
Through-beam
E3JM-10□4(T)

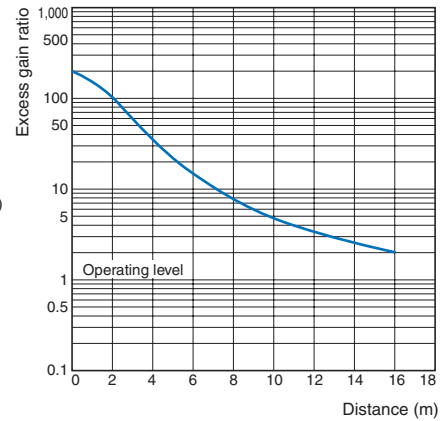

Excess Gain Ratio vs. Set Distance (Typical)
Retro-reflective
E3JM-R4□4(T) (When Using E39-R1)

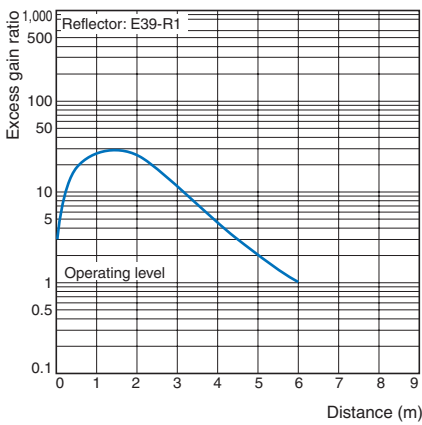

Excess Gain Ratio vs. Set Distance (Typical)
Retro-reflective
E3JM-R4□4(T) (When Using E39-R3)

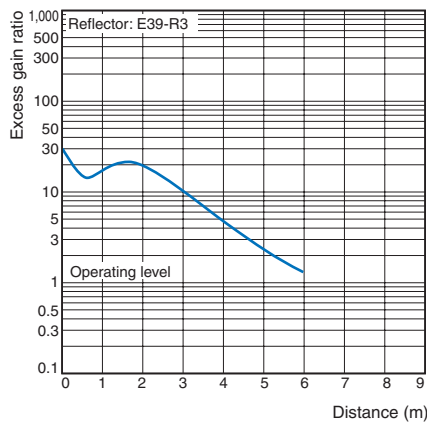

Excess Gain Ratio vs. Set Distance (Typical)
Diffuse-reflective
E3JM-DS70□4(T)

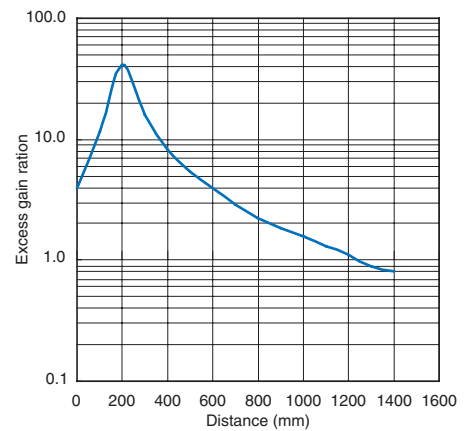

Operation

Output Circuit

Relay Output Models

E3JM-□M4(T)

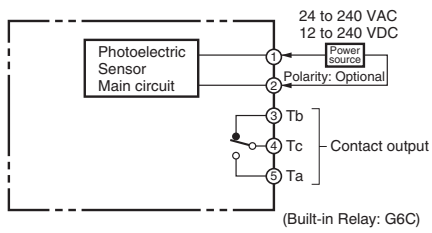

DC SSR Output Models

E3JM-□S4(T)

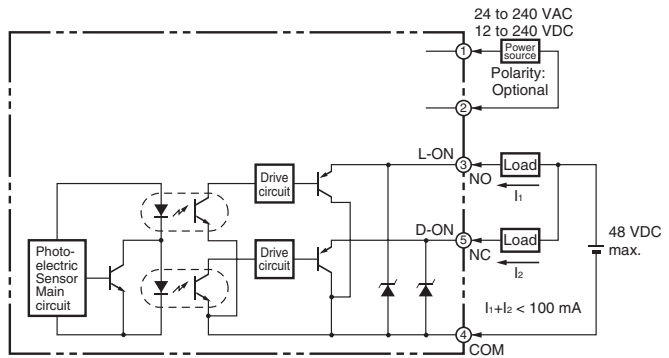

E3JM-□R4(T)

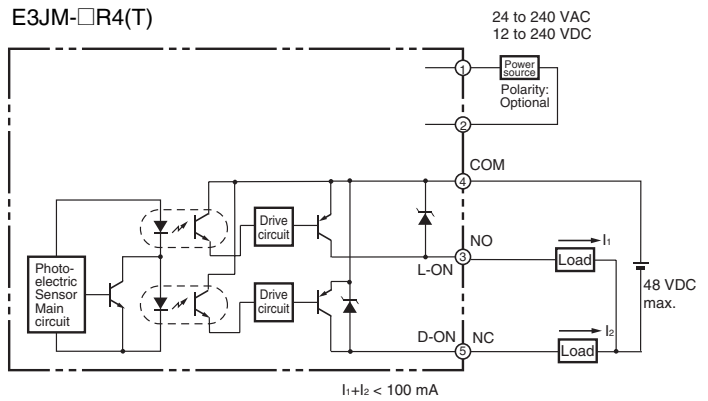

Timing Charts

Models without Timer

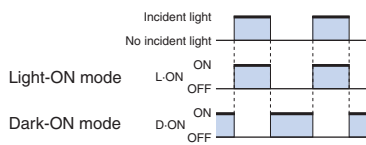

Models with Timer

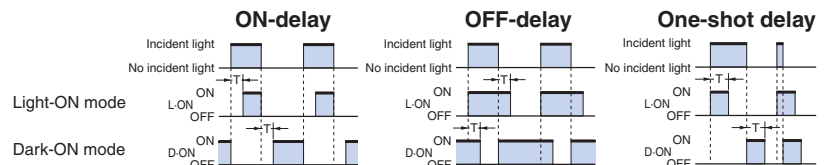

Precautions

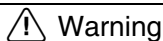

Warning

This product is not designed or rated for ensuring safety of persons. Do not use it for such purposes.

Connections

Through-beam Models

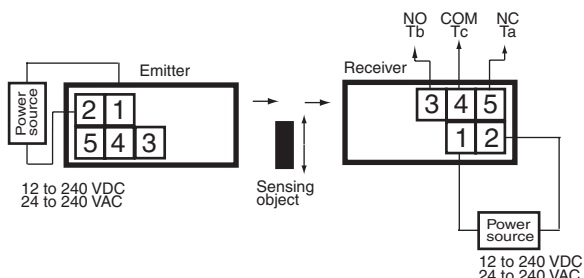

Retro-reflective Models

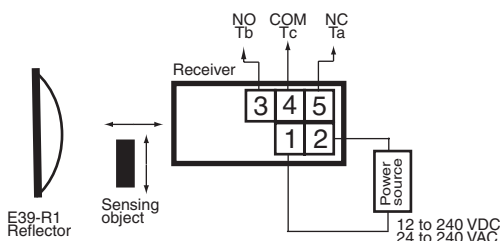

Diffuse-reflective Models

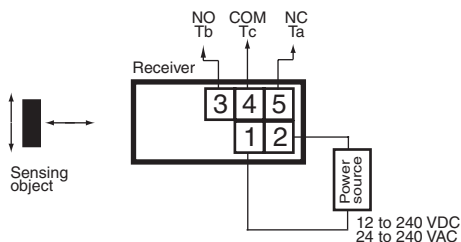

Adjustment

Through-beam Models

For a E3JM with the timer function, the indicator will be lit when incident light is received while the mode is switched to Light-ON, and the indicator will be lit when light is interrupted while the mode is switched to Dark-ON.

Move the Emitter and Receiver horizontally and vertically, and locate them to the center of the range in which the Receiver indicator is lit.

Retro-reflective Models

The indicator of the Retro-reflective Model with the timer function is lit in the same way as for the Through-beam Model.

As with the Through-beam Model, adjust the Reflector and Sensor. Since the directional angle of the E3JM Retro-reflective Model is 1 to 5 degrees, pay careful attention when adjusting the Sensor.

Diffuse-reflective Models

The indicator of the Diffuse-reflective Model with the timer function is lit in the same way as for the Through-beam Model.

Sensing object is present.

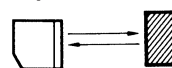

Sensing object is not present.

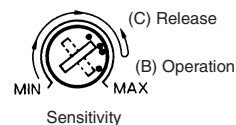
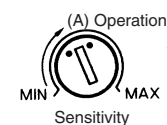
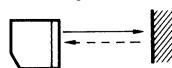

1. If a sensing object is present as shown above, turn the sensitivity adjuster clockwise to increase the sensitivity. Point (A) is where the indicator is lit.
2. Remove the sensing object and turn the adjuster clockwise. Point (B) is where the indicator is lit by background objects.
3. Turn the adjuster counterclockwise to decrease the sensitivity, starting from the point (B). Point (C) is where the indicator is lit.
4. The center point between the point (A) and point (C) is the optimum position. If the indicator is not lit by the background object at the maximum sensitivity, set to the center point between the point (A) and the maximum sensitivity.

Note: The sensitivity adjuster may be damaged if an excessive force is applied.

Precautions for Correct Use

Switch Configuration

Models without Timer

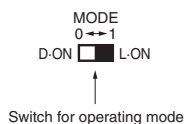

Models with Timer

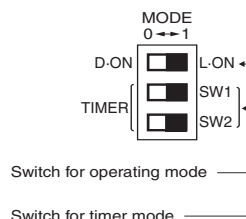

Switch Selection

Models without Timer

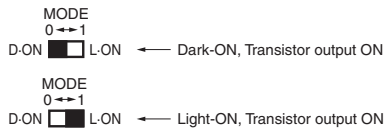

Models with Timer

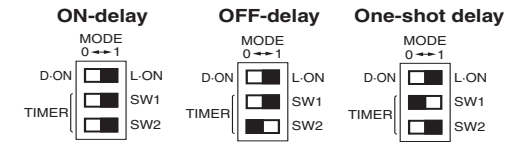

Note: The switch for the operating mode is the same as that for models without a timer.

Connecting and Wiring

Recommended outer diameter of cables is from 6 to 8 dia. Be sure to firmly tighten the cover in order to maintain waterproof and dustproof properties.

Cable End Treatment

Adjust the four wires to the same length when the Ta output is to be used only. If both the Ta and Tb outputs are to be used, treat them as shown in the following diagram.

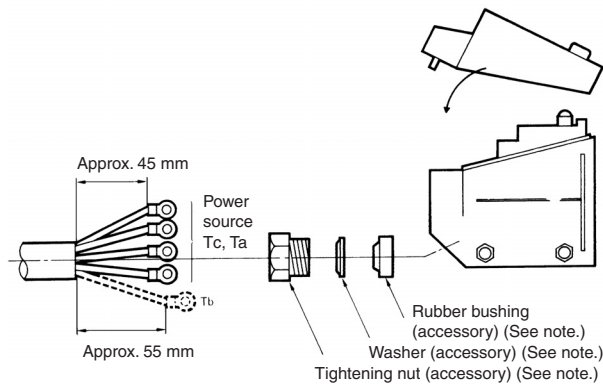

Recommended Crimp Terminal Dimensions

(Unit: mm)

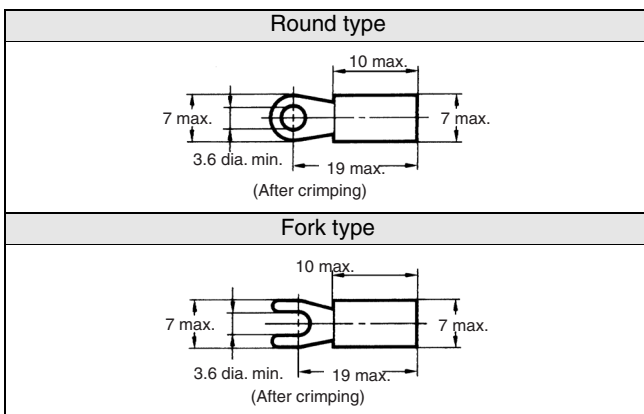

Note: Use terminals with insulation tube (recommended crimp terminal: 1.25 to 3.5).

Terminal Protection Cover (Accessory)

The terminal protection cover is designed to improve safety by maintaining the sensitivity properties of the product and by preventing any contact with charged sections while it is being operated with the mode set to the timer mode. Mount the product as shown in the following diagram (mount the Through-beam Model on the Receiver side).

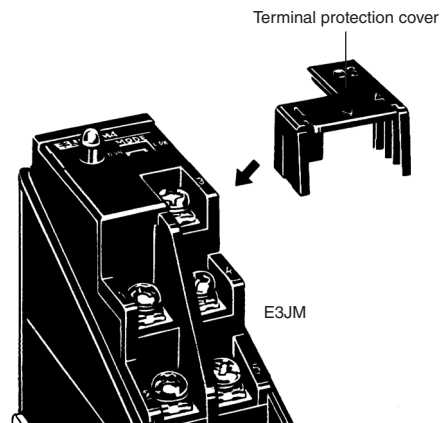

Output Relay Contact

If a load, such as contactor or valve is used that may produce arc when it is turned OFF, the NC (or NO) side may turn ON before the NO (or NC) side is turned OFF. When using both the NC and NO outputs, use an arc killer.

Connecting and Wiring DC SSR Output Models

When using the DC SSR output model, the total of the load current for the Light-ON output (NO) and that for the Dark-ON (NC) should be 100 mA max. If the total exceeds 100 mA, the load short-circuit protection function will be activated (this function will be reset when the power of the Photoelectric Sensor is turned OFF).

Ambient Conditions (Installation Area)

The E3JM will malfunction if installed in the following places.

- Places where the E3JM is exposed to a dusty environment.
- Places where corrosive gases are produced.

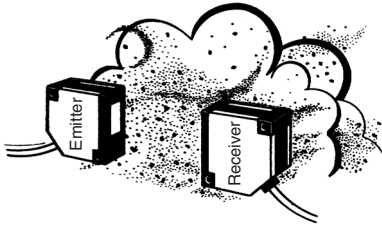

- Places where the E3JM is directly exposed to water, oil, or chemicals.

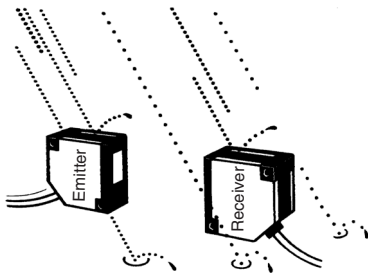

Dimensions

- Note**
1. The operating mode switch and timer mode switch are located inside the cover.
 2. All units are in millimeters unless otherwise indicated.

E3JM-10□4T

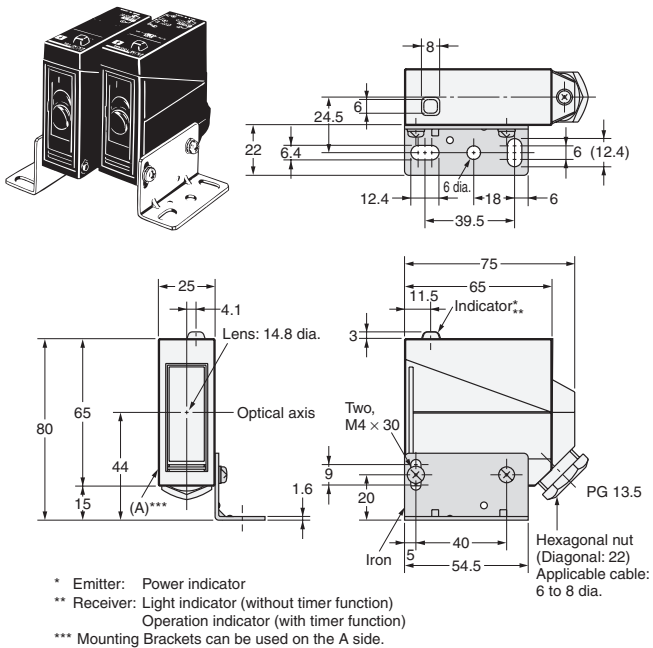

E3JM-DS70□4(T)
E3JM-R4□4(T)

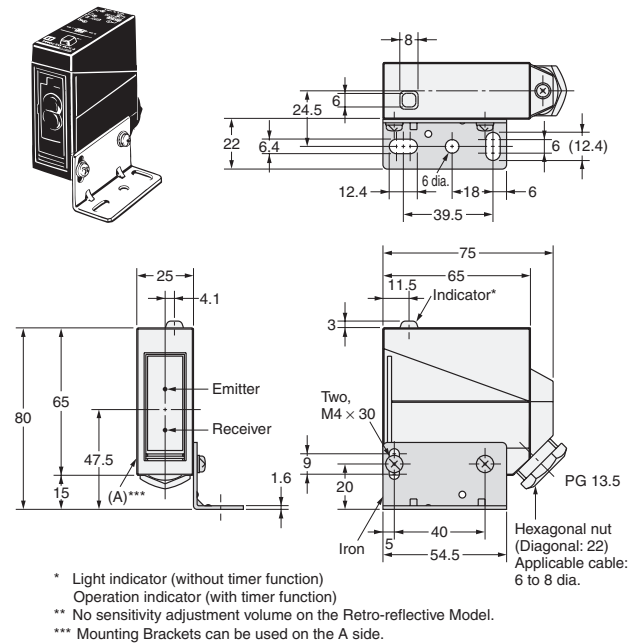

Reflectors

E39-R1 (Provided with Retro-reflective Models)

Materials: Reflective side: PMMA (Acrylic resin)
Back side: ABS resin

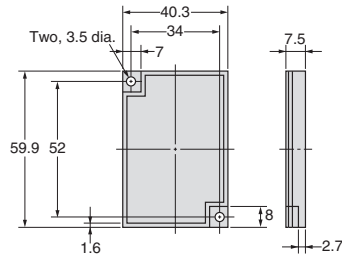

Seal-type Long Slit
E39-S39

Materials: Polyester
0.1-mm thick

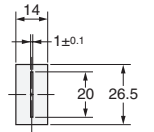

Small Reflector (Order Separately)

E39-R3

Materials: Reflective side: PMMA (Acrylic resin)
Back side: ABS resin

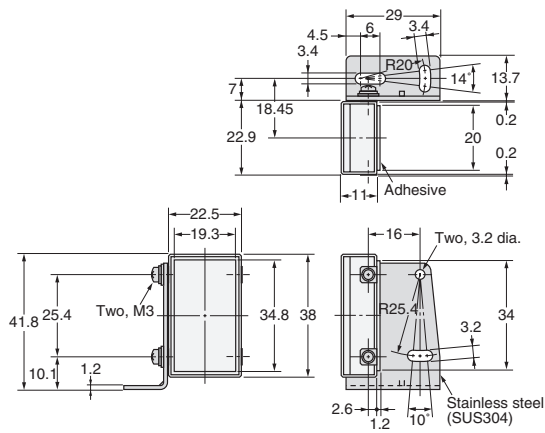
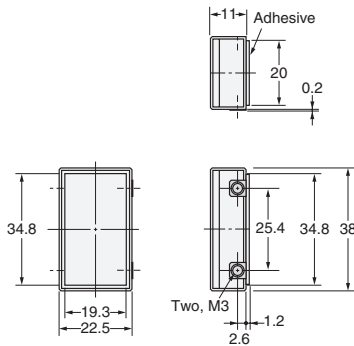

Tape Reflectors (Order Separately)

E39-RS1

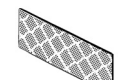

Materials: Acrylic

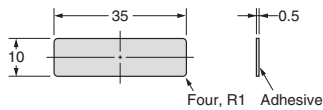

E39-RS3

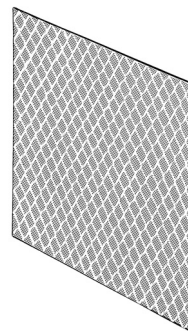

Materials: Acrylic

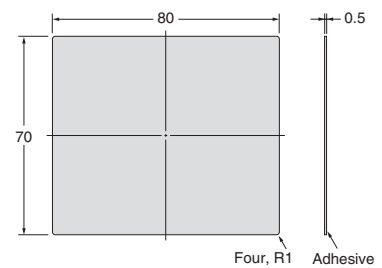

E39-RS2

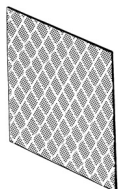

Materials: Acrylic

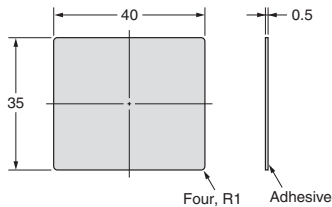

WARRANTY

OMRON's exclusive warranty is that the products are free from defects in materials and workmanship for a period of one year (or other period if specified) from date of sale by OMRON.

OMRON MAKES NO WARRANTY OR REPRESENTATION, EXPRESS OR IMPLIED, REGARDING NON-INFRINGEMENT, MERCHANTABILITY, OR FITNESS FOR PARTICULAR PURPOSE OF THE PRODUCTS. ANY BUYER OR USER ACKNOWLEDGES THAT THE BUYER OR USER ALONE HAS DETERMINED THAT THE PRODUCTS WILL SUITABLY MEET THE REQUIREMENTS OF THEIR INTENDED USE. OMRON DISCLAIMS ALL OTHER WARRANTIES, EXPRESS OR IMPLIED.

LIMITATIONS OF LIABILITY

OMRON SHALL NOT BE RESPONSIBLE FOR SPECIAL, INDIRECT, OR CONSEQUENTIAL DAMAGES, LOSS OF PROFITS OR COMMERCIAL LOSS IN ANY WAY CONNECTED WITH THE PRODUCTS, WHETHER SUCH CLAIM IS BASED ON CONTRACT, WARRANTY, NEGLIGENCE, OR STRICT LIABILITY.

In no event shall responsibility of OMRON for any act exceed the individual price of the product on which liability is asserted.

IN NO EVENT SHALL OMRON BE RESPONSIBLE FOR WARRANTY, REPAIR, OR OTHER CLAIMS REGARDING THE PRODUCTS UNLESS OMRON'S ANALYSIS CONFIRMS THAT THE PRODUCTS WERE PROPERLY HANDLED, STORED, INSTALLED, AND MAINTAINED AND NOT SUBJECT TO CONTAMINATION, ABUSE, MISUSE, OR INAPPROPRIATE MODIFICATION OR REPAIR.

SUITABILITY FOR USE

THE PRODUCTS CONTAINED IN THIS DOCUMENT ARE NOT SAFETY RATED. THEY ARE NOT DESIGNED OR RATED FOR ENSURING SAFETY OF PERSONS, AND SHOULD NOT BE RELIED UPON AS A SAFETY COMPONENT OR PROTECTIVE DEVICE FOR SUCH PURPOSES. Please refer to separate catalogs for OMRON's safety rated products.

OMRON shall not be responsible for conformity with any standards, codes, or regulations that apply to the combination of products in the customer's application or use of the product.

At the customer's request, OMRON will provide applicable third party certification documents identifying ratings and limitations of use that apply to the products. This information by itself is not sufficient for a complete determination of the suitability of the products in combination with the end product, machine, system, or other application or use.

The following are some examples of applications for which particular attention must be given. This is not intended to be an exhaustive list of all possible uses of the products, nor is it intended to imply that the uses listed may be suitable for the products:

- Outdoor use, uses involving potential chemical contamination or electrical interference, or conditions or uses not described in this document.
- Nuclear energy control systems, combustion systems, railroad systems, aviation systems, medical equipment, amusement machines, vehicles, safety equipment, and installations subject to separate industry or government regulations.
- Systems, machines, and equipment that could present a risk to life or property.

Please know and observe all prohibitions of use applicable to the products.

NEVER USE THE PRODUCTS FOR AN APPLICATION INVOLVING SERIOUS RISK TO LIFE OR PROPERTY WITHOUT ENSURING THAT THE SYSTEM AS A WHOLE HAS BEEN DESIGNED TO ADDRESS THE RISKS, AND THAT THE OMRON PRODUCT IS PROPERLY RATED AND INSTALLED FOR THE INTENDED USE WITHIN THE OVERALL EQUIPMENT OR SYSTEM.

PERFORMANCE DATA

Performance data given in this document is provided as a guide for the user in determining suitability and does not constitute a warranty. It may represent the result of OMRON's test conditions, and the users must correlate it to actual application requirements. Actual performance is subject to the OMRON Warranty and Limitations of Liability.

CHANGE IN SPECIFICATIONS

Product specifications and accessories may be changed at any time based on improvements and other reasons.

It is our practice to change model numbers when published ratings or features are changed, or when significant construction changes are made. However, some specifications of the product may be changed without any notice. When in doubt, special model numbers may be assigned to fix or establish key specifications for your application on your request. Please consult with your OMRON representative at any time to confirm actual specifications of purchased products.

DIMENSIONS AND WEIGHTS

Dimensions and weights are nominal and are not to be used for manufacturing purposes, even when tolerances are shown.

ERRORS AND OMISSIONS

The information in this document has been carefully checked and is believed to be accurate; however, no responsibility is assumed for clerical, typographical, or proofreading errors, or omissions.

PROGRAMMABLE PRODUCTS

OMRON shall not be responsible for the user's programming of a programmable product, or any consequence thereof.

Cat. No. E203-E2-05

In the interest of product improvement, specifications are subject to change without notice.

OMRON EUROPE B.V.

Wegalaan 67-69,
NL-2132 JD, Hoofddorp,
The Netherlands
Phone: +31 23 568 13 00
Fax: +31 23 568 13 88
www.industrial.omron.eu