

NEW

OMRON

SMART Sensor Series

Laser Displacement Sensor CMOS Type
Model ZX2 Series

Stable, Easy & Affordable

New Regular-reflective Sensor Head
Designed for Optimal Wafer Measurement



realizing

One Solution for Any Application

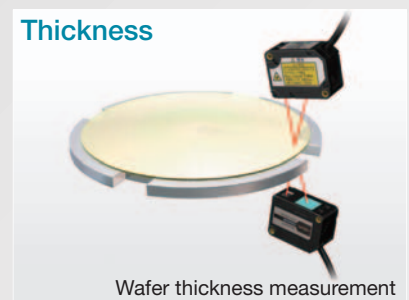
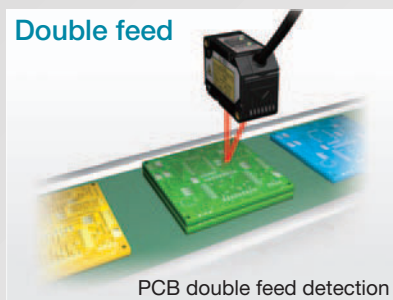
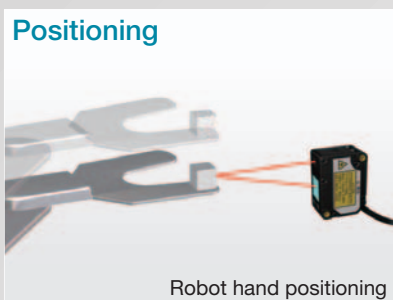
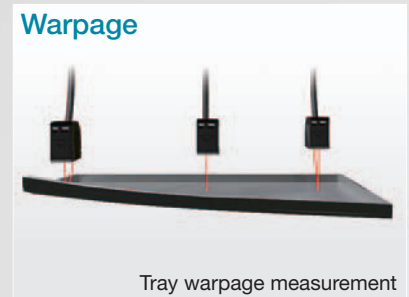
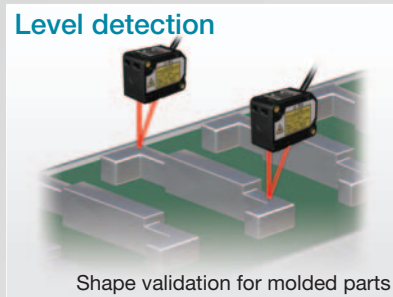

New Laser Displacement Sensor CMOS Type ZX2 Series

Realize stable measurements

Resolution 1.5 μ m^{*1}

Reliable measurement of moving objects

**Measurement cycle
30 μ s**

Stable Wafer Measurement **NEW**

**Regular-reflective
Sensor Head**

Realize stable measurements at 10 μ m

Linearity^{*2} 0.05% F.S.^{*3}

Unaffected by environmental changes

**Temperature characteristic^{*4}
0.02% F.S./ $^{\circ}$ C^{*5}**

*1 When employing Models ZX2-LD50/LD50L (50mm type)

*2 Linearity : Maximum error produced when measuring within measurement range

*3 A linearity of $\pm 0.05\%$ F.S. indicates that the maximum error is 10 μ m when the ZX2-LD50L is used with a 40 to 50-mm measurement range, or 35 μ m when the ZX2-LD100L is used with a 65 to 100-mm measurement range.

*4 Temperature characteristic : Error produced when the ambient temperature varies by 1 $^{\circ}$ C

*5 Linearity $\pm 0.02\%$ F.S./ $^{\circ}$ C indicates the maximum error is 4 μ m when the ambient temperature varies by 1 $^{\circ}$ C in the case of using Models ZX2-LD50/LD50L with a measurement range ± 10 mm.



Stable Measurement and Easy to Use

Stability Stable measurements in case of color/material and moving objects

Dynamic range of two million times

Stable measurements are enabled for any color or surface condition, including metals, substrates, elastomers, and transparent materials, through OMRON's unique HSDR-CMOS (High Speed and Dynamic Range) image sensor and a step-less laser power adjustment algorithm.

A line beam is used in addition to an emitter beam when dealing with rough surfaces to average out the amount of reflected light and to offset the amount of light received at a high-speed measurement period of 30 μ s in order to reduce variations in received light and to enable stable measurements for moving objects.

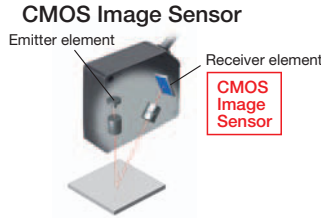

Step-less adjustment of laser power

For high reflectance, brightly colored workpiece

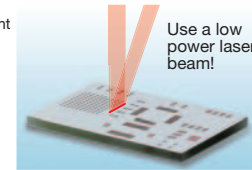

For low reflectance, darkly colored workpiece

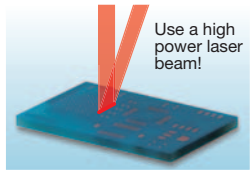

PAT.P

Stable measurements on objects with changing color/material

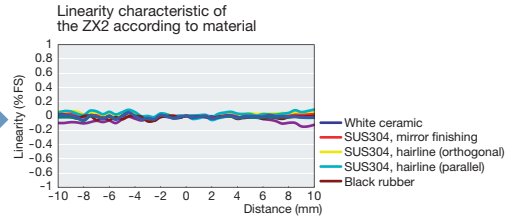
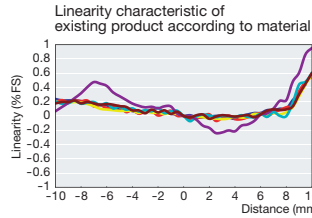

Stable measurements on moving objects

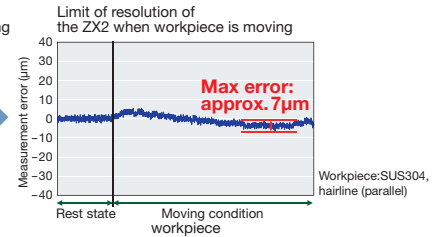

Easy Easy and User-friendly Configuration

Smart tuning

The ideal configuration for stable measurements is realized by a single button through the new feature "smart tuning", and no longer depends on the skill of the user. A reliable configuration is achieved by three tuning methods, which can be selected to match the type of object and surface conditions to be measured.

Sensor configuration by just a pushing the SMART button



PAT.P

Three selectable tunings

One type of workpiece



Single smart tuning
Best configuration for stable detection in case of objects do not change by pushing the button for one second

Several types of workpiece



Multi-smart tuning
Ideal configuration for stable detection of changing objects by pushing the button for three seconds

Surface conditions of the workpiece are variable



Active smart tuning
Continuous configuration improvement for the stable detection of all locations by pushing the button for five seconds

Sensor Heads for Various Applications-select the Range and Type of Beam

New Regular-reflective Sensor Head Designed for Optimal Wafer Measurement

ZX2-LD50L Line beam type
ZX2-LD50 Spot beam type

● Measurement range	50mm±10mm
● Resolution	1.5µm
● Linearity	Line beam ±0.05%F.S. ^{*1} Spot beam ±0.10%F.S. ^{*1}
● Beam size	Line beam Approx.60µm×2.6mm Spot beam Approx.60µm dia.

Spot beam

Precise measurement on micro-scale objects

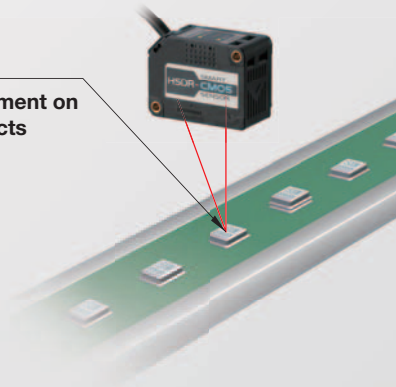

NEW

ZX2-LD50V Spot beam type
 (regular-reflective)

● Measurement range	48mm±5mm
● Resolution	1.5µm
● Linearity	Spot beam ±0.3%F.S.
● Beam size	Spot beam Approx.60µm dia.

Regular-reflective

Stable wafer measurement

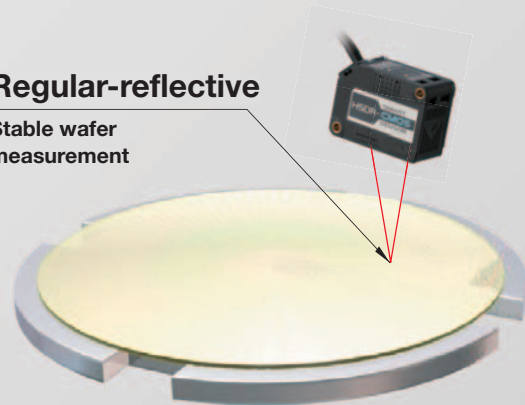

ZX2-LD100L Line beam type
ZX2-LD100 Spot beam type

● Measurement range	100mm±35mm
● Resolution	5µm
● Linearity	Line beam ±0.05%F.S. ^{*2} Spot beam ±0.10%F.S. ^{*2}
● Beam size	Line beam Approx.110µm×2.7mm Spot beam Approx.110µm dia.

Line beam

Stable measurement on rough-surfaced objects

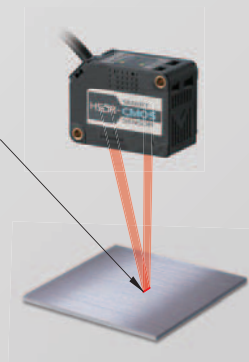

*1 Using 40 to 50mm
 *2 Using 65 to 100mm



Support for Various Environments/Space-Saving ●●● The Smart Sensor Head

Reliable measurements in harsh environments

IP67, robot cable & temperature characteristic 0.02% F.S./°C

IP67 protection class enables to use the sensor in harsh environments. A robot cable is used as standard between the head and amplifier, that the unit can be used reliably on moving parts. In addition, as 3D UV bond is used to fix the optical components rather than screws, stress can be controlled and a temperature characteristic 0.02% F.S./°C* is realized.

* If the room temperature varies 1°C, the measured value varies 0.02% F.S. (corresponding to 4µm for the Model ZX2-LD50)



Compact sensor for easy mounting

World smallest*

The world's smallest CMOS laser displacement sensor head is realized in a resin case. Enables to mount the sensor in smallest spaces and to minimize measurement errors arising from temperature fluctuations.

* According to OMRON investigation of CMOS laser displacement sensors performed in September 2010.

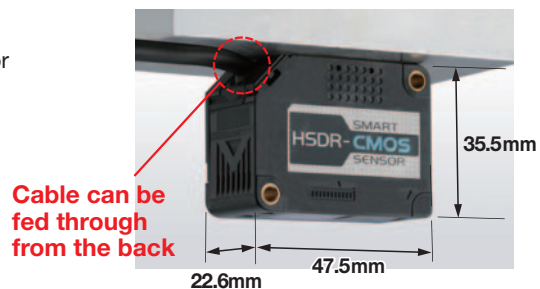

10µm precision measurements

Linearity to meet the application

Measurements to an even higher accuracy are realized for applications that do not require the entire measurement range. If the range of the field is less than the length of the measurement center, linearity accuracy improves by 50% compared with that for the full range.*

* For the ZX2-LD50L/LD100L.

Model ZX2-LD50L

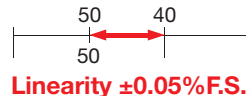

Example of an application that does not require the entire measurement range
Low-profile connector assembly height measurement

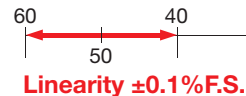

Example of an application that requires the entire measurement range
Robot hand registration

Visualization to prevent from stopping the production-line

Laser life display function

The end of the laser diode lifespan is automatically detected and displayed so maintenance can be performed systematically. On the main digital display of the amplifier, this is indicated by an LED on the back of the head. Accordingly, in case of amplifier is within the control panel, the lifetime can be confirmed by the head and the indications are not missed.



Ease of Use by “LED Display” and “Calculating Unit”

11-segment LED display for intuitive configuration



Easy calculations of measurements

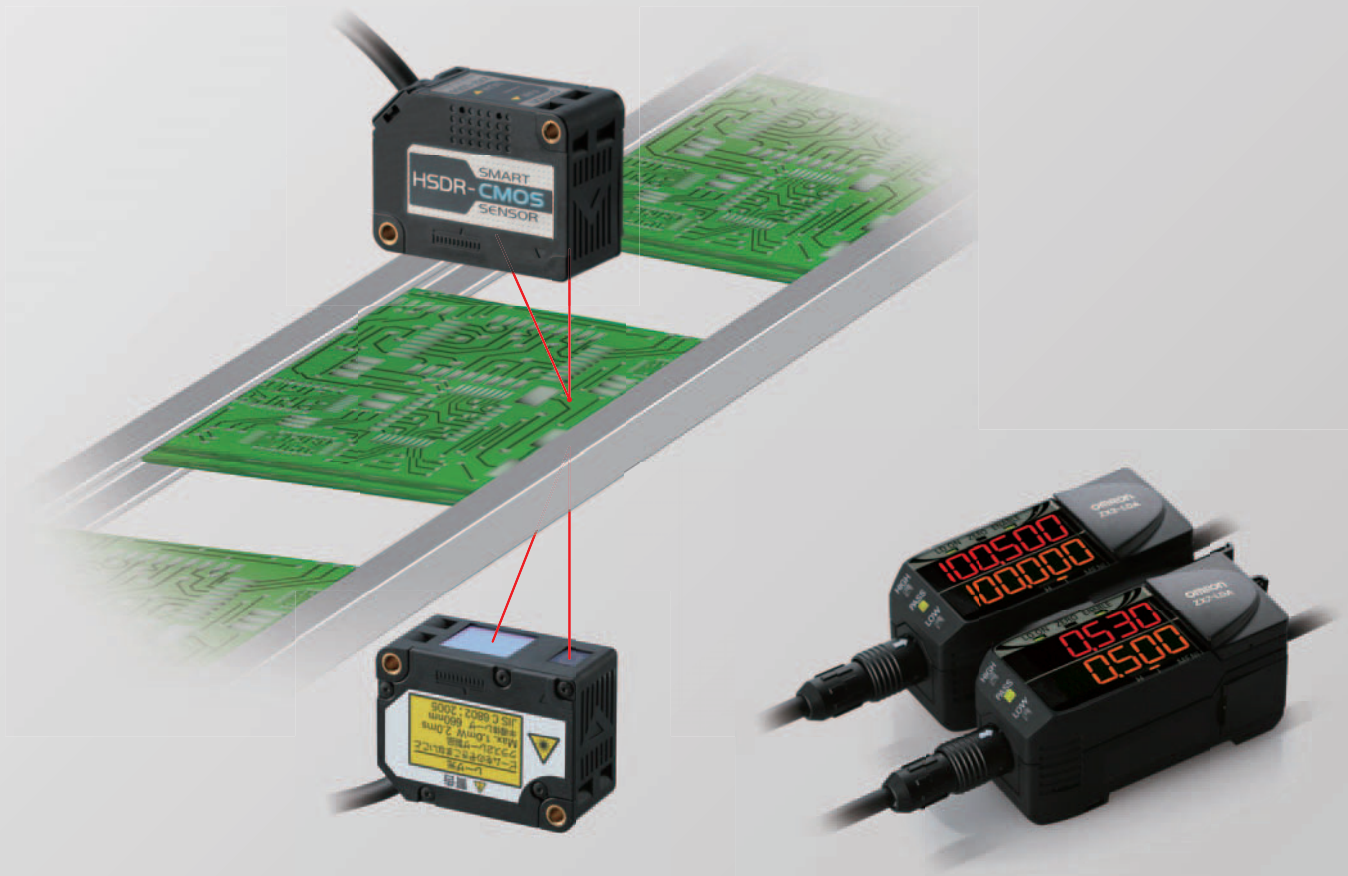



A thorough pursuit of user-friendliness ●●● The Smart Amplifier Unit

No need for a manual

11 Segment LED Display

An 11 segment LED display is integrated in the compact housing. Alphanumeric characters can be read with ease and there is no need to refer to a manual.



Comparison of the existing 7 segment LED display and the 11 segment LED display

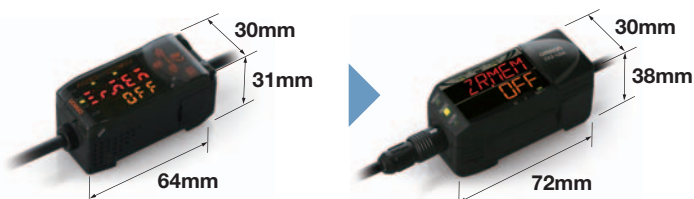
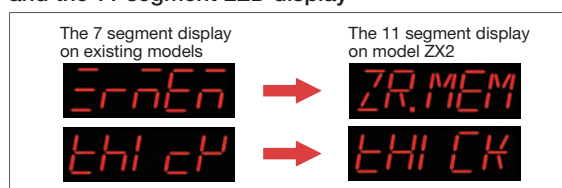

The compact housing stays just as it is

Perform two calculations with ease

Thickness + subtraction mode

The calculated results of two sensor heads are displayed on the amplifier unit by just connecting the calculating unit between the two amplifier units. The calculation function can be chosen from the two modes of thickness and subtraction. It is also possible to prevent mutual interference by coupling via the calculating units. (Up to five amplifier units can be connected.)

Thickness mode

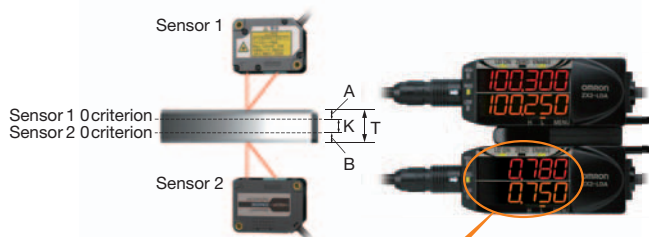

Thickness $T = K + (A + B)$

Subtraction mode

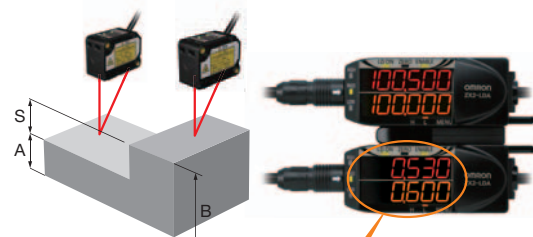

Level difference $S = B - A$

Easy change of setup

Equipped with 4 banks

The amplifier unit is equipped with four bank functions. Easy change of setup between four modes is supported by just switching between the bank functions.

Existing models



Amplifier unit + Bank unit

ZX2



Built into the unit

One Sensor for Any Measurement Application

Height/ Length

Height measurements prior to IC package sealing

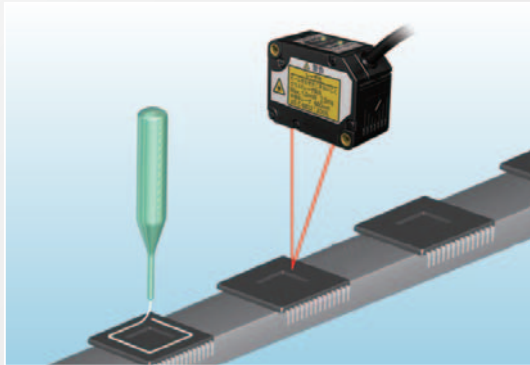

Point Stable measurements can be performed by the HSDR-CMOS image sensor and Omron's proprietary algorithm, even for measurements on moving IC packages.

Level detection

Shape validation for molded parts

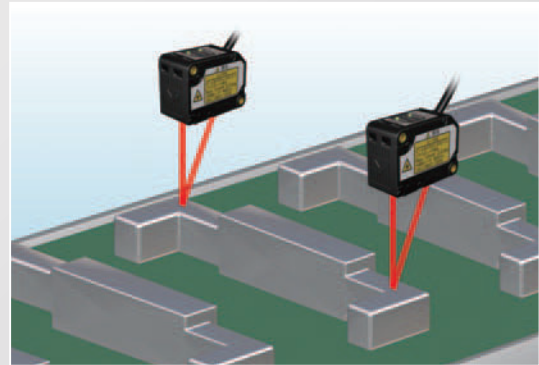

Point Calculation of the measured values can be carried out and the difference in level can be easily measured by just connecting the calculating unit between two amplifiers. Even if the surface conditions of a molded part varies, application of a line beam and HSDR-CMOS image sensor results in almost no fluctuation in measured value.

Warpage

Tray warping measurement before chip baking

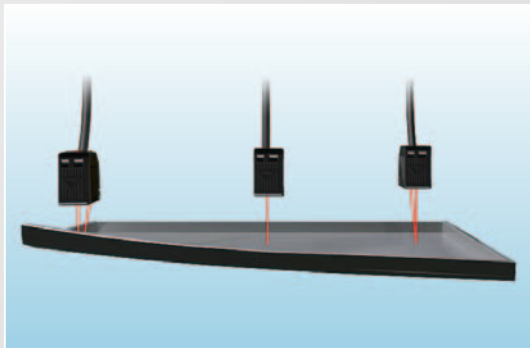

Point Even if there is temperature variation due to the ambient temperature, a die-cast is used for the optical base and so there is almost no fluctuation in measured value.

Positioning

Robot hand Positioning

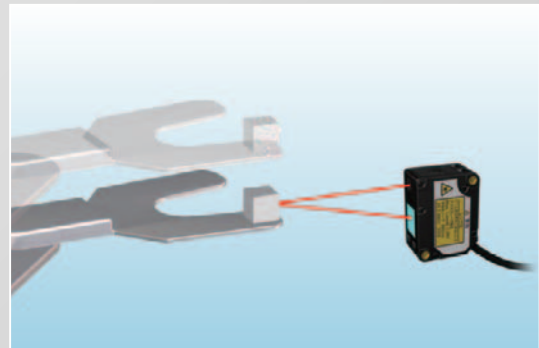

Point Stable measurements can be performed by the HSDR-CMOS image sensor and Omron's proprietary algorithm even for robot hand registration.

Double feed

PCB double feed detection

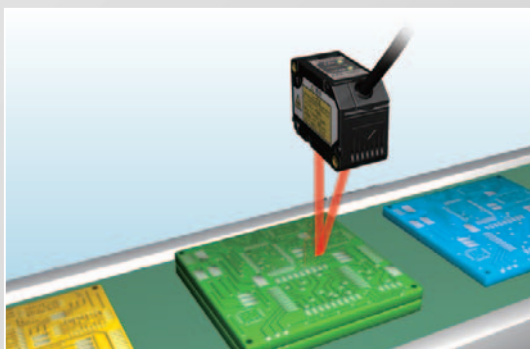

Point Even if the color of the substrate changes, application of the HSDR-CMOS image sensor and Omron's proprietary algorithm results in almost no fluctuation in measured value.

Thickness

Wafer thickness measurement

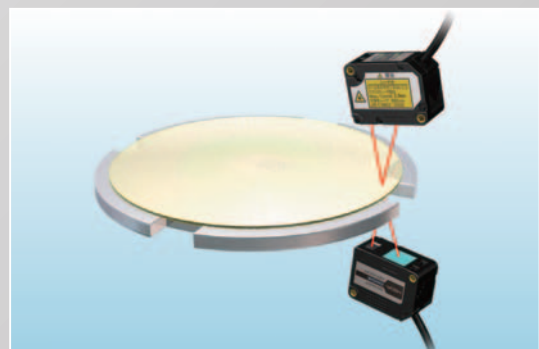

Point You can easily measure thicknesses by using Regular-reflective Sensor Heads and connecting a Calculating Unit between the two Amplifier Units to perform calculations.

Ordering Information

Units

Sensor Heads

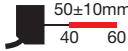
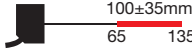
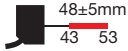
Appearance	Optical system	Beam shape	Sensing distance	Resolution	Model
	Diffuse reflective	Line beam	 50±10mm 40 60	1.5µm	ZX2-LD50L
		Spot beam			ZX2-LD50
		Line beam	 100±35mm 65 135	5µm	ZX2-LD100L
		Spot beam			ZX2-LD100
	Regular reflective	Spot beam	 48±5mm 43 53	1.5µm	ZX2-LD50V

Amplifier Units

Appearance	Power supply	Output type	Model
	DC	NPN	ZX2-LDA11
		PNP	ZX2-LDA41

Accessories (sold separately) These are not included with the Sensor Head or Amplifier Unit. Please order as necessary.

Calculating Unit



Appearance	Model
	ZX2-CAL

Sensor Head Extension Cables

Cable Length	Model
1m	ZX2-XC1R
4m	ZX2-XC4R
9m	ZX2-XC9R
20m	ZX2-XC20R

* Extension cables cannot be coupled and used together.

Mounting Brackets

Applicable Sensor Heads	Appearance	Model	Contents
ZX2-LD50V ZX2-LD50L ZX2-LD50		E39-L178	Mounting Bracket: 1 Nut plate: 1 Phillips screws (M3×30): 2
ZX2-LD100L ZX2-LD100		E39-L179	

Specifications

Diffuse-reflective Sensor Heads

Item	Model	ZX2-LD50L	ZX2-LD50	ZX2-LD100L	ZX2-LD100
Optical system	Diffuse reflective				
Light source (wave length)	Visible-light semiconductor laser with a wavelength of 660 nm and an output of 1mW max. EN class 2,FDA class II*5				
Measurement center point	50mm			100mm	
Measurement range	±10mm			±35mm	
Beam shape	Line	Spot		Line	Spot
Beam size *1	Approx. 60µm×2.6mm	Approx. 60µm dia.		Approx.110µm×2.7mm	Approx.110µm dia.
Resolution *2	1.5µm			5µm	
Linearity *3	±0.05%F.S. (40 to 50mm) ±0.1%F.S. (entire range)	±0.1%F.S. (40 to 50mm) ±0.15%F.S. (entire range)	±0.05%F.S. (65 to 100mm) ±0.1%F.S. (entire range)		±0.1%F.S. (65 to 100mm) ±0.15%F.S. (entire range)
Temperature characteristic *4	0.02%F.S./°C				
Ambient illumination	Incandescent lamp: 10,000lx max. (on light receiving side)				
Ambient temperature	Operating: 0 to +50°C, Storage: -15 to +70°C (with no icing or condensation)				
Ambient humidity	Operating and storage: 35% to 85% (with no condensation)				
Dielectric strength	1,000 VAC, 50/60 Hz for 1 minute				
Vibration resistance (destruction)	10 to 150 Hz, 0.7-mm double amplitude, 80 minutes, each in X,Y,and Z directions				
Shock resistance (destruction)	300 m/s ² 3 times each in six directions (up/down,left/right,forward/backward)				
Degree of protection	IEC60529, IP67				
Connection method	Connector connection (standard cable length: 500 mm)				
Weight (packed state)	Approx.160g (Sensor Head only: Approx.75g)				
Materials	Case and cover: PBT (polybutylene terephthalate), Optical window: Glass, Cable: PVC				
Accessories	Instruction sheet, Ferrite core, Laser warning label (English), FDA certification label				

Regular-reflective Sensor Head

Item	Model	ZX2-LD50V
Optical system	Regular reflective	
Light source (wave length)	Visible-light semiconductor laser with a wavelength of 660 nm and an output of 0.24 mW max. EN class 1, FDA class I*5	
Measurement center point	48mm	
Measurement range	±5mm	
Beam shape	Spot	
Beam size *1	Approx. 60µm dia.	
Resolution *2	1.5µm	
Linearity *3	±0.3%F.S. (entire range)	
Temperature characteristic *4	0.06%F.S./°C	
Ambient illumination	Incandescent lamp: 10,000lx max. (on light receiving side)	
Ambient temperature	Operating: 0 to +50°C, Storage: -15 to +70°C (with no icing or condensation)	
Ambient humidity	Operating and storage: 35% to 85% (with no condensation)	
Dielectric strength	1,000 VAC, 50/60 Hz for 1 minute	
Vibration resistance (destruction)	10 to 150 Hz, 0.7-mm double amplitude, 80 minutes, each in X,Y,and Z directions	
Shock resistance (destruction)	300 m/s ² 3 times each in six directions (up/down,left/right,forward/backward)	
Degree of protection	IEC 60529, IP67	
Connection method	Connector connection (standard cable length: 500 mm)	
Weight (packed state)	Approx.160g (Sensor Head only: Approx.75g)	
Materials	Case and cover: PBT (polybutylene terephthalate), Optical window: Glass, Cable: PVC	
Accessories	Instruction sheet, Ferrite core, Laser warning label (English)	

Note) False detection outside the measurement range can occur in the case of an object with high reflectance.

*1. Beam size: Defined as 1/e² (13.5%) of the central intensity at the smallest value of diameter for the measurement range (typical value)

False detections can occur in the case there is light leakage outside the defined region and the surroundings of the target object have a high reflectance in comparison to the target object.

*2. Resolution: indicates the degree of fluctuation (±3σ) of analog output when connected to the ZX2-LDA.

(The measured value is given for the center distance for OMRON's standard target object (diffuse-reflective models: white ceramic object, regular-reflective models: 1/4 λ flat mirror) when the response time of the ZX2-LDA is set to 128 ms.)

Indicates the repetition accuracy for when the workpiece is in a state of rest. Not an indication of distance accuracy. Resolution performance may not be satisfied in a strong electromagnetic field.

*3. Linearity: indicates the error with respect to the ideal straight line of the displacement output in the case of measuring Omron's standard target object. Linearity and measured value may vary depending on target object.

F.S. indicates the full scope of the measurement range. (ZX2-LD50 (L): 20mm)

*4. Temperature characteristic: Value for the case the space between the sensor head and Omron's standard target object is secured by an aluminum jig. (Measured at the measurement center distance)

*5. These Sensors are classified as Class 2 laser devices for diffuse-reflective models and Class 1 for regular-reflective models under EN 60825-1 and the regulations of Laser Notice No. 50 for FDA certification. CDRH registration has been completed for diffuse-reflective models and is scheduled for regular-reflective model.

Amplifier Units

Item	Model	ZX2-LDA11	ZX2-LDA41
Measurement period *1		Min. 30μs	
Response time		60μs, 120μs, 240μs, 500μs, 1ms, 2ms, 4ms, 8ms, 12ms, 20ms, 36ms, 66ms, 128ms, 250ms, 500ms	
Analog output *2		4 to 20 mA, Max. load resistance: 300Ω, ±5VDC or 1 to 5 VDC, Output impedance: 100Ω	
Judgement outputs (HIGH/PASS/LOW: 3 outputs), error output		NPN open-collector outputs, 30 VDC, 50 mA max. (residual voltage: 1V max. for load current 10mA max., 2V max. for load current above 10mA)	PNP open-collector outputs, 30 VDC, 50 mA max. (residual voltage: 1V max. for load current 10mA max., 2V max. for load current above 10mA)
Laser OFF input, zero reset input, timing input, reset input, bank input		ON: Short-circuited with 0-V terminal or 1.2V or less OFF: Open (leakage current: 0.1 mA max.)	ON: Supply voltage short-circuited or supply voltage within -1.2V OFF: Open (leakage current: 0.1 mA max.)
Functions		Smart tuning, scaling, sample hold, peak hold, bottom hold, peak-to-peak hold, self-peak hold, self-bottom hold, average hold, zero reset, On-delay timer, OFF-delay timer, keep/clamp switch, (A-B)calculations *3, thickness calculation *3, mutual interference prevention *3, laser deterioration detection, bank function(4 banks), differential function	
Indications		Judgement indicators: HIGH(orange),PASS(green),LOW(orange),11-segment main display(red),11-segment sub-display(orange),laser ON(green),zero reset(green),enable(green),menu(green), HIGH threshold(orange),LOW threshold(orange)	
Power supply voltage		10 to 30 VDC, including 10% ripple(p-p)	
Power consumption		3,000 mW max. with power supply voltage of 30 VDC and power supply current of 100 mA (with Sensor connected)	
Ambient temperature		Operating: 0 to +50°C, Storage: -15 to +70°C (with no icing or condensation)	
Ambient humidity		Operating and storage: 35% to 85% (with no condensation)	
Dielectric strength		1,000 VAC, 50/60 Hz for 1 minute	
Vibration resistance (destruction)		10 to 150 Hz, 0.7-mm double amplitude, 80 minutes, each in X,Y,and Z directions	
Shock resistance (destruction)		300 m/s ² 3 times each in six directions (up/down,left/right,forward/backward)	
Degree of protection		IEC60529, IP40	
Connection method		Prewired (standard cable length: 2 m)	
Weight (packed state)		Approx.200g (Amplifier Unit only: Approx.135g)	
Materials		Case: PBT(polybutylene terephthalate), Cover: Polycarbonate, Display: Acrylic resin, Button: Polyacetal, Cable: PVC	
Accessories		Instruction sheet	

*1. In the case of Omron's standard target object (white ceramic)

*2. Configure current output (4 to 20mA) and voltage output (±5V or 1 to 5V) by MENU mode.

*3. Calculating unit (ZX2-CAL) is necessary. Calculations are possible for two amplifier units. Mutual interference prevention is possible for up to five amplifier units.

Calculating Unit

Item	Model	ZX2-CAL
Applicable Amplifier Units		ZX2-LDA11/ZX2-LDA41
Current consumption		12mA max (supplied from the Smart Sensor Amplifier Unit)
Ambient temperature		Operating: 0 to +50°C, storage: -15 to +70°C (with no icing or condensation)
Ambient humidity		Operating and storage: 35 to 85% (with no condensation)
Connection method		Connector
Dielectric strength		1,000VAC, 50/60 Hz for 1minute
Vibration resistance (destructive)		10 to 150Hz, 0.7-mm double amplitude, 80minutes, each in X,Y,and Z directions
Shock resistance (destructive)		300m/s ² 3 times each in six directions (up/down, left/right, forward/backward)
Materials		Case: ABS, Display: Acrylic resin
Weight (packed state)		Approx. 50g (Calculating Unit only: Approx. 15g)
Accessories		Instruction sheet

Engineering Data (Typical)

Angle Characteristic

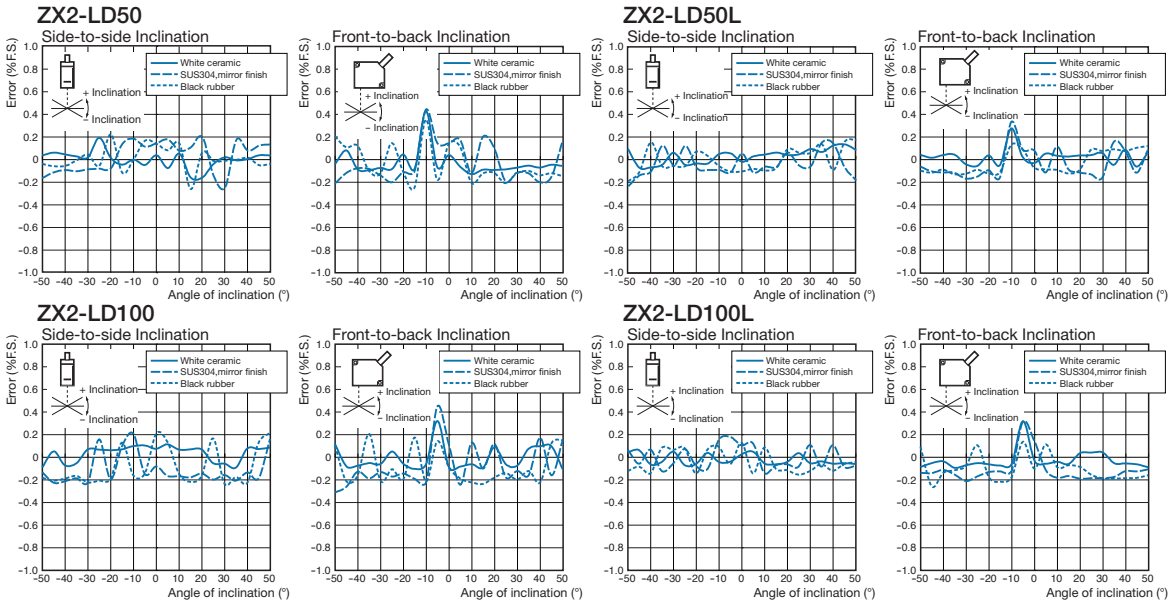

Linearity Characteristic for Different Materials

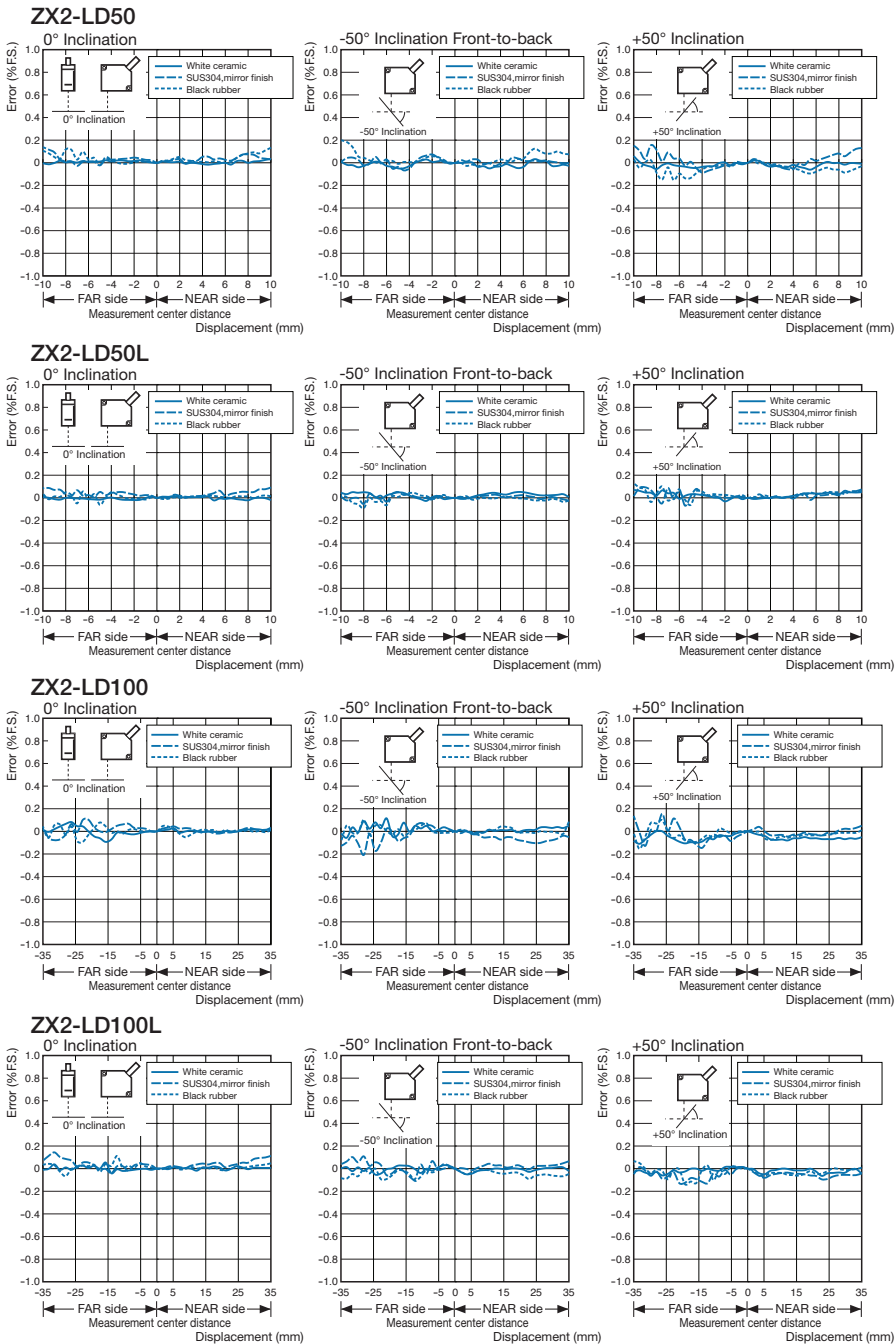

* The x-axis displacement indicates the measurement distance displayed by the amplifier unit. The measurement distance displayed by the amplifier unit takes the measurement center distance as 0 and displays the near-side from the sensor as plus and the far-side as minus.

Angle Characteristic

ZX2-LD50V

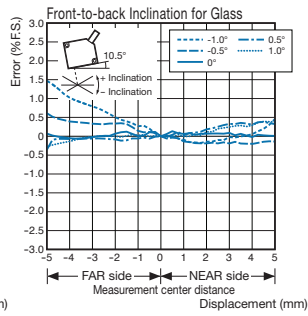
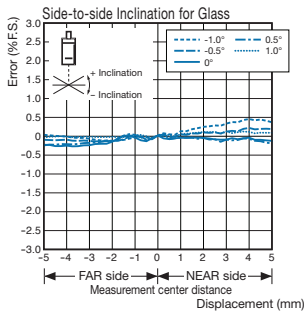
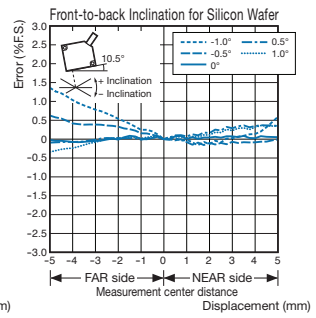
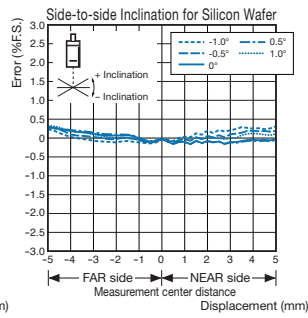
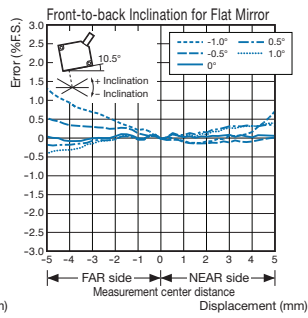
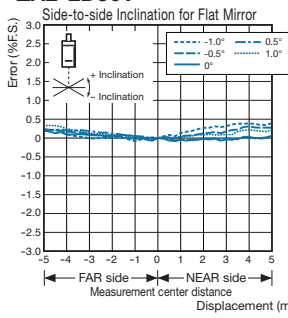

Linearity Characteristic for Different Materials

ZX2-LD50V

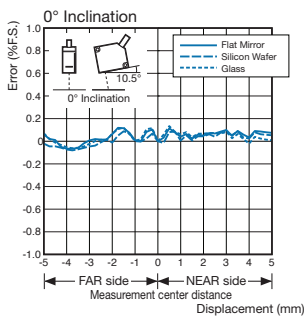

* The x-axis displacement indicates the measurement distance displayed by the amplifier unit. The measurement distance displayed by the amplifier unit takes the measurement center distance as 0 and displays the near-side from the sensor as plus and the far-side as minus.

Dimensions

(Unit: mm)

Units

Sensor Heads

ZX2-LD50/ZX2-LD50L
ZX2-LD100/ZX2-LD100L
ZX2-LD50V

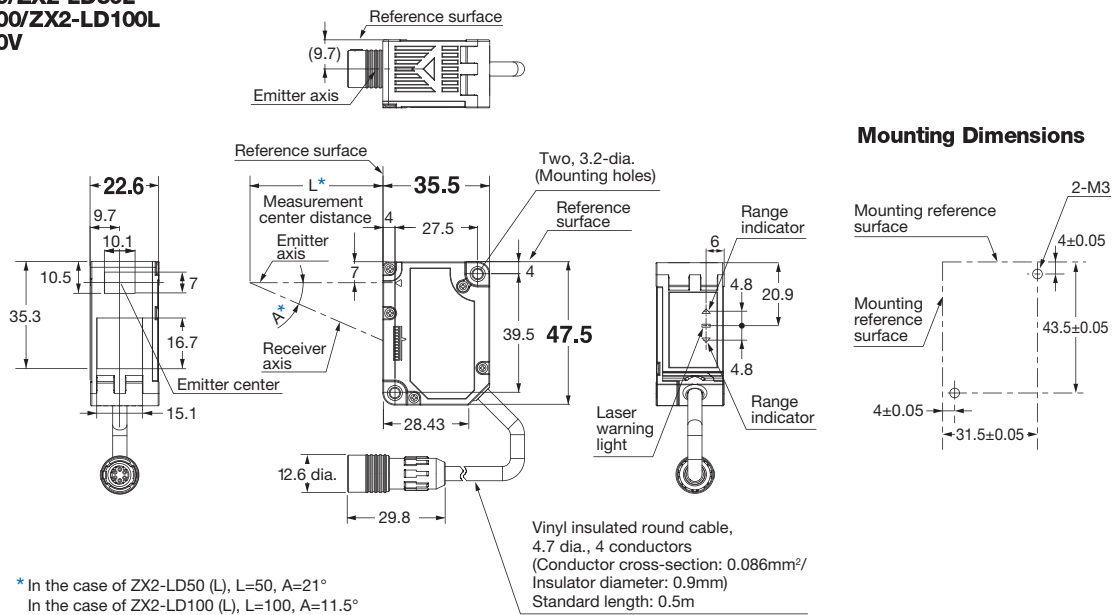

Amplifier Units

ZX2-LDA11/ZX2-LDA41

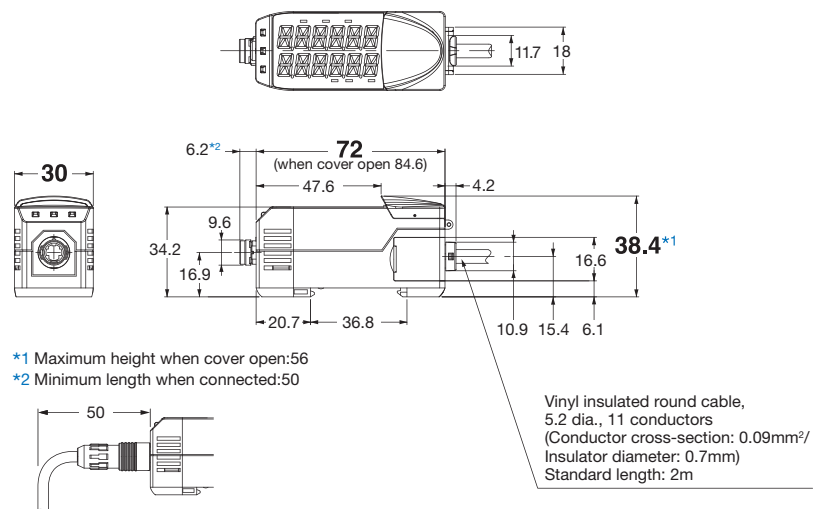

Accessories

Calculating Unit

ZX2-CAL

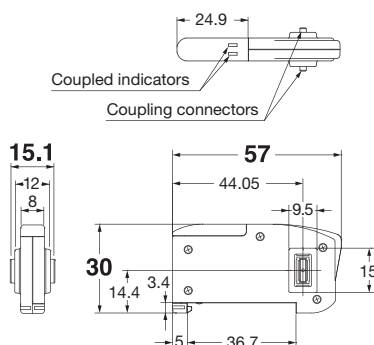

Sensor Head Extension Cables

ZX2-XC1R
ZX2-XC4R
ZX2-XC9R
ZX2-XC20R

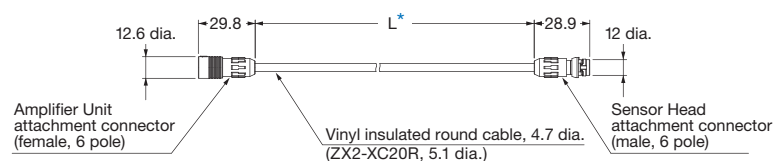

* Length L is as follows. ZX2-XC1R:1m, ZX2-XC4R:4m, ZX2-XC9R:9m, ZX2-XC20R:20m

Mounting Bracket E39-L178

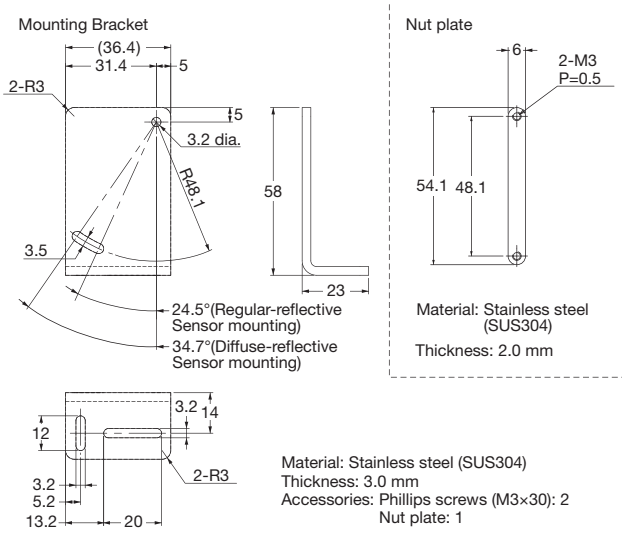

Mounting Bracket E39-L179

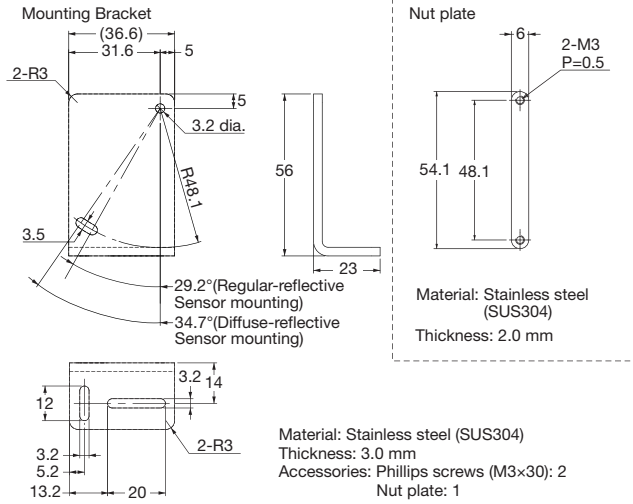

* Use this Mounting Bracket when installing the ZX2-LD100 (L) as a normal Diffuse-reflective or Regular-reflective Sensor Head.

Installation Method for Regular-reflective Sensor Head

Using a E39-L178 Mounting Bracket:

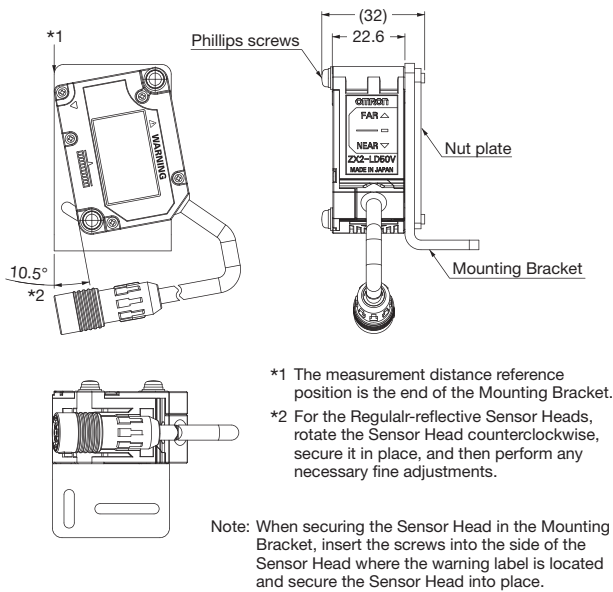

Installation Method for Regular-reflective Sensor Heads (Installing a Diffuse-reflective Sensor Head as a Regular-reflective Sensor Head)

Using a E39-L179 Mounting Bracket:

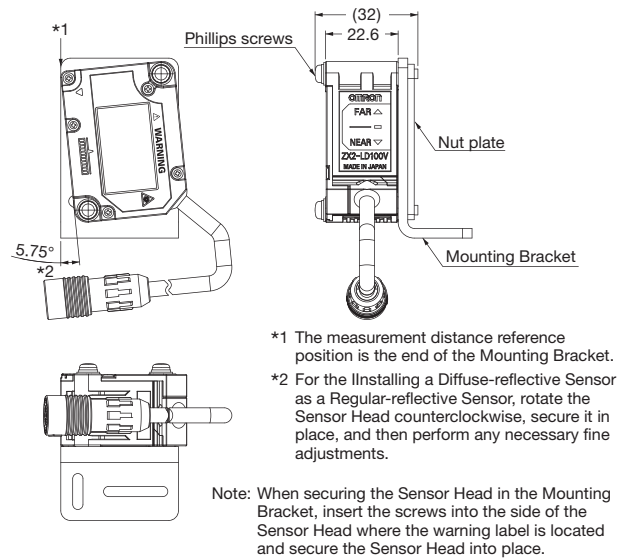

Not Using a Mounting Bracket:

Tilt the Sensor Head towards the workpiece as shown below.

ZX2-LD50V

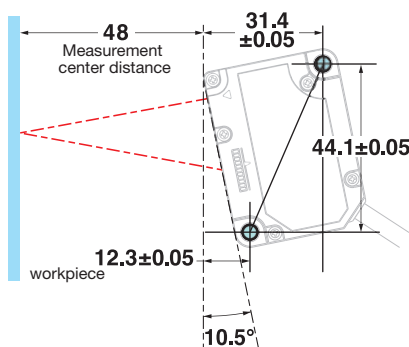

Installation Method for Diffuse-reflective Sensor Heads Using a E39-L178, E39-L179 Mounting Bracket

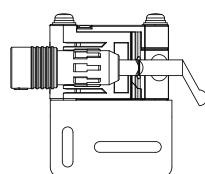
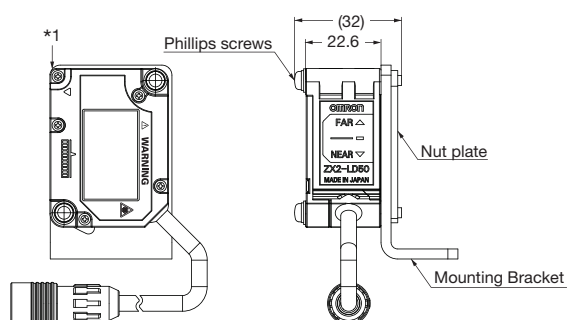

*1 The measurement distance reference position is the Sensor's sensing surface.

Note: When securing the Sensor Head in the Mounting Bracket, insert the screws into the side of the Sensor Head where the warning label is located and secure the Sensor Head into place.

Not Using a Mounting Bracket:

Mount the Sensor Head in relation to the workpiece as shown below.

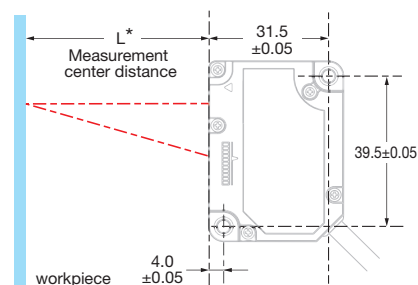

* ZX2-LD50 (L): 50
ZX2-LD100 (L): 100

OMRON Corporation Industrial Automation Company
Tokyo, JAPAN

Contact: www.ia.omron.com

Regional Headquarters

OMRON EUROPE B.V.
Sensor Business Unit
Carl-Benz-Str. 4, D-71154 Nufringen, Germany
Tel: (49) 7032-811-0/Fax: (49) 7032-811-199

OMRON ASIA PACIFIC PTE. LTD.
No. 438A Alexandra Road # 05-05/08 (Lobby 2),
Alexandra Technopark,
Singapore 119967
Tel: (65) 6835-3011/Fax: (65) 6835-2711

OMRON ELECTRONICS LLC
One Commerce Drive Schaumburg,
IL 60173-5302 U.S.A.
Tel: (1) 847-843-7900/Fax: (1) 847-843-7787

OMRON (CHINA) CO., LTD.
Room 2211, Bank of China Tower,
200 Yin Cheng Zhong Road,
PuDong New Area, Shanghai, 200120, China
Tel: (86) 21-5037-2222/Fax: (86) 21-5037-2200

Authorized Distributor:

© OMRON Corporation 2010 All Rights Reserved.
In the interest of product improvement,
specifications are subject to change without notice.

CSM_5_1_0911
Cat. No. E406-E1-02

Printed in Japan
(0711)