

# Basic type digital temperature controller

# E5GN (48 x 24 mm)

## New 48 x 24-mm Basic Temperature Controller with enhanced functionality and performance.

- Indication Accuracy
  - Thermocouple input:  $\pm 0.3\%$  of PV (previous models:  $\pm 0.5\%$ )
  - Pt input:  $\pm 0.2\%$  of PV (previous models:  $\pm 0.5\%$ )
  - Analog input:  $\pm 0.2\%$  FS (previous models:  $\pm 0.5\%$ ).
- PV/SV-status display: this function can alternate displaying the status of the Temperature Controller (auto/manual, RUN/STOP, and alarms) and the PV or SV.
- Preventive maintenance for relays in the Temperature Controller using a Control Output ON/OFF Counter.
- Switch the PV display between three colors.
- Compatible with Support Software (CX-Thermo version 4.2 or higher).
- Eleven-segment displays.
- Models are available with one or two alarm outputs.
- Logic Operations to perform simple PLC tasks.



E5GN-□-C  
Models with Screwless Clamp  
Terminal Blocks  
48 x 24 mm



Refer to *Safety Precautions* on page 18.

## Main I/O Functions

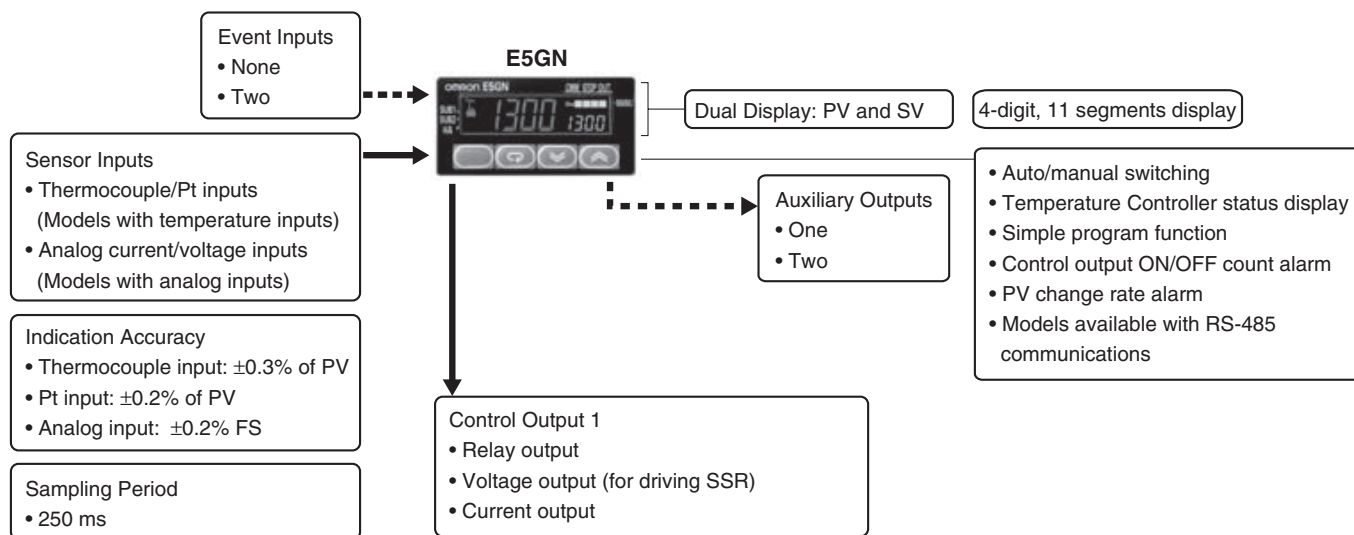

This datasheet is provided as a guideline for selecting products. Be sure to refer to the following user manuals for application precautions and other information required for operation before attempting to use the product.

E5CN/E5AN/E5EN/E5GN Digital Temperature Controllers User's Manual Basic Type (Cat. No. H156)

E5CN/E5AN/E5EN/E5GN Digital Temperature Controllers Communications Manual Basic Type (Cat. No. H158)

# Lineup

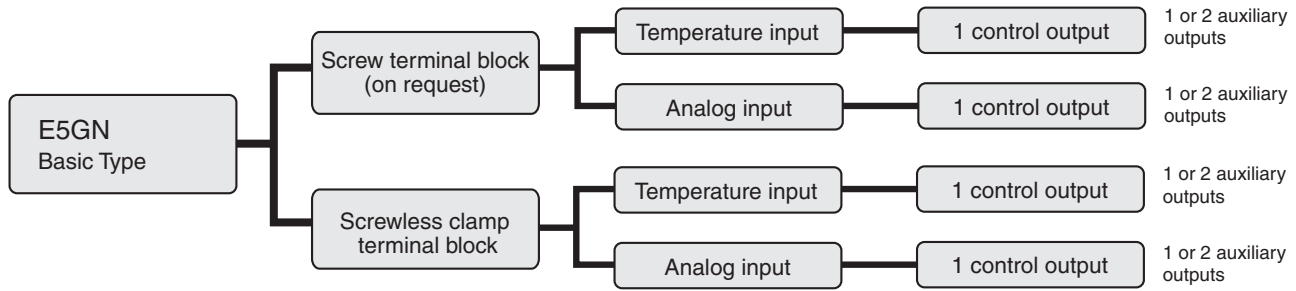

## Model Number Structure

### Model Number Legend

#### Controllers

E5GN-          -  -  -    
           1 2 3 4 5   6 7 8

#### 1. Control Output 1

- R: Relay output
- Q: Voltage output (for driving SSR)
- C: Linear current output

#### 2. Auxiliary Outputs

- 1: One output
- 2: Two outputs

#### 3. Option

- Blank: None
- 03: RS-485 communications
- B: Two event inputs
- H: Heater burnout/Heater short/Heater overcurrent detection (CT1)

#### 4. Input Type

- T: Universal thermocouple/platinum resistance thermometer input
- L: Analog current/voltage input

#### 5. Power Supply Voltage

- Blank: 100 to 240 VAC
- D: 24 VAC/VDC

#### 6. Terminal Type

- C: Models with screwless clamp terminal block

#### 7. Case Color

- Blank: Black

#### 8. Communications Protocol

- Blank: None
- FLK: CompoWay/F communications

**Note:** Models cannot be made for all combinations of options that are possible in the model number legend. Confirm model availability in *Ordering Information* before ordering.

\* Auxiliary outputs are relay outputs that can be used to output alarms or processing results.

\* Screw terminal block models available on request.

## Models with Temperature Inputs

### Models with One Control Output and a 100 to 240-VAC Power Supply

Case color	Control output	Control mode <sup>1</sup>	No. of auxiliary outputs	Detection of heater burnout, SSR failure, and heater overcurrent	No. of event inputs	Transfer output <sup>2</sup>	Communi-cations <sup>3</sup>	Previous model		New model
								Thermo-couple input	Resistance thermo-meter input	
Black	Relay output	Standard or heating/cooling	1	---	---	---	---	E5GN-R1TC	E5GN-R1P	E5GN-R1T-C
					2			---	---	E5GN-R1BT-C
					---			E5GN-R03TC-FLK	E5GN-R03P-FLK	E5GN-R103T-C-FLK
			2	Detection for single-phase heaters	---		---	E5GN-R2T-C		
					2		---	E5GN-R2HT-C		
					---		---	E5GN-R2BT-C		
	Voltage output (for driving SSR)	Standard or heating/cooling	1	---	---	---	---	E5GN-Q1TC	E5GN-Q1P	E5GN-Q1T-C
					2			---	---	E5GN-Q1BT-C
					---			E5GN-Q03TC-FLK	E5GN-Q03P-FLK	E5GN-Q103T-C-FLK
			2	Detection for single-phase heaters	---		---	E5GN-Q2T-C		
					2		---	E5GN-Q2HT-C		
					---		---	E5GN-Q2BT-C		
	Current output	Standard or heating/cooling	1	---	---	Transfer output using control output	---	---	---	E5GN-C1T-C
					2			---	---	E5GN-C1BT-C
					---			---	---	E5GN-C103T-C-FLK
					RS-485		---	---	---	E5GN-C1T-C
							---	---	---	E5GN-C1BT-C
							---	---	---	E5GN-C103T-C-FLK

<sup>1</sup>. If heating/cooling control mode is used, an auxiliary output is used as a control output for the cooling side. The number of auxiliary outputs that can be used will decrease by one. Also, the signal for the control output for the cooling side will be a relay output.  
<sup>2</sup>. A current control output can be used as the transfer output. In that case, an auxiliary output is used as the control output. The control output will be a relay output. The number of auxiliary outputs that can be used will decrease by one.  
<sup>3</sup>. RS-232-C communication models available on request.

Models with One Control Output and a 24-VAC/VDC Power Supply

Case color	Control output	Control mode <sup>1</sup>	No. of auxiliary outputs	Detection of heater burnout, SSR failure, and heater overcurrent	No. of event inputs	Transfer output <sup>2</sup>	Communi-cations <sup>3</sup>	Previous model		New model	
								Thermo-couple input	Resistance thermo-meter input		
Black	Relay output	Standard or heating/cooling	1	---	---	---	---	E5GN-R1TC	E5GN-R1P	E5GN-R1TD-C	
					2			---	---	E5GN-R1BTD-C	
					RS-485			E5GN-R03TC-FLK	E5GN-R03P-FLK	E5GN-R103TD-C-FLK	
			---	---			E5GN-R2TD-C				
			---	---			---	E5GN-R2HTD-C			
				---	---		E5GN-R2BTD-C				
	RS-485	---		---	E5GN-R203TD-C-FLK						
		Voltage output (for driving SSR)	Standard or heating/cooling	1	---	---	---	---	E5GN-Q1TC	E5GN-Q1P	E5GN-Q1TD-C
						2			---	---	E5GN-Q1BTD-C
	RS-485					E5GN-Q03TC-FLK			E5GN-Q03P-FLK	E5GN-Q103TD-C-FLK	
				---	---	E5GN-Q2TD-C					
				---	---	---		E5GN-Q2HTD-C			
	---				---	E5GN-Q2BTD-C					
	RS-485	---	---		E5GN-Q203TD-C-FLK						
		Current output	Standard or heating/cooling	1	---	---	Transfer output using control output	---	---	---	E5GN-C1TD-C
2						---			---	E5GN-C1BTD-C	
---	RS-485					---			---	E5GN-C103TD-C-FLK	

<sup>1</sup>. If heating/cooling control mode is used, an auxiliary output is used as a control output for the cooling side. The number of auxiliary outputs that can be used will decrease by one. Also, the signal for the control output for the cooling side will be a relay output.  
<sup>2</sup>. A current control output can be used as the transfer output. In that case, an auxiliary output is used as the control output. The control output will be a relay output. The number of auxiliary outputs that can be used will decrease by one.  
<sup>3</sup>. RS-232-C communication models available on request.

**Models with Analog Inputs**

**Models with One Control Output and a 100 to 240-VAC Power Supply**

Case color	Control output	Control mode <sup>*1</sup>	No. of auxiliary outputs	Detection of heater burnout, SSR failure, and heater overcurrent	No. of event inputs	Transfer output <sup>*2</sup>	Communications	Previous model		New model
								Thermocouple input	Resistance thermometer input	
Black	Current output	Standard or heating/cooling	1	---	---	Transfer output using control output	---	---	---	E5GN-C1L-C

- \*1. If heating/cooling control mode is used, an auxiliary output is used as a control output for the cooling side. The number of auxiliary outputs that can be used will decrease by one. Also, the signal for the control output for the cooling side will be a relay output.
- \*2. A current control output can be used as the transfer output. In that case, an auxiliary output is used as the control output. (This is not possible for models without an auxiliary output.) The control output will be a relay output. The number of auxiliary outputs that can be used will decrease by one.

**Note:** Models with analog inputs do not display the temperature unit.

**Models with One Control Output and a 24-VAC/VDC Power Supply**

Case color	Control output	Control mode <sup>*1</sup>	No. of auxiliary outputs	Detection of heater burnout, SSR failure, and heater overcurrent	No. of event inputs	Transfer output <sup>*2</sup>	Communications	Previous model		New model
								Thermocouple input	Resistance thermometer input	
Black	Current output	Standard or heating/cooling	1	---	---	Transfer output using control output	---	---	---	E5GN-C1LD-C

- \*1. If heating/cooling control mode is used, an auxiliary output is used as a control output for the cooling side. The number of auxiliary outputs that can be used will decrease by one. Also, the signal for the control output for the cooling side will be a relay output.
- \*2. A current control output can be used as the transfer output. In that case, an auxiliary output is used as the control output. (This is not possible for models without an auxiliary output.) The control output will be a relay output. The number of auxiliary outputs that can be used will decrease by one.

**Accessories (Order Separately)**

**USB-Serial Conversion Cable**

Model
E58-CIFQ1

**Waterproof Packing**

Model
Y92S-32

**Current Transformers (CTs)**

Hole diameter	Model
5.8 dia.	E54-CT1
12.0 dia.	E54-CT3

**CX-Thermo Support Software**

Model
EST2-2C-MV4

**Note:** The E5GN is supported by CX-Thermo version 4.2 and higher.

## Specifications

### Ratings

<b>Power supply voltage</b>	No D in model number: 100 to 240 VAC, 50/60 Hz D in model number: 24 VAC, 50/60 Hz; 24 VDC	
<b>Operating voltage range</b>	85% to 110% of rated supply voltage	
<b>Power consumption</b>	100 to 240 VAC: 5.5 VA (max.) 24 VAC/VDC: 3 VA/2 W (max.)	
<b>Sensor input</b>	Models with temperature inputs Thermocouple: K, J, T, E, L, U, N, R, S, B, W, or PL II Platinum resistance thermometer: Pt100 or JPt100 Infrared temperature sensor: 10 to 70°C, 60 to 120°C, 115 to 165°C, or 140 to 260°C Voltage input: 0 to 50 mV	
	Models with analog inputs Current input: 4 to 20 mA or 0 to 20 mA Voltage input: 1 to 5 V, 0 to 5 V, or 0 to 10 V	
<b>Input impedance</b>	Current input: 150 Ω max., Voltage input: 1 MΩ min. (Use a 1:1 connection when connecting the ES2-HB.)	
<b>Control method</b>	ON/OFF control or 2-PID control (with auto-tuning)	
<b>Control outputs</b>	<b>Relay output</b>	SPST-NO, 250 VAC, 2 A (resistive load), electrical life: 100,000 operations, minimum applicable load: 5 V, 10 mA
	<b>Voltage output (for driving SSR)</b>	Output voltage: 12 VDC ±15% (PNP), max. load current: 21 mA, with short-circuit protection circuit
	<b>Current output</b>	4 to 20 mA DC/0 to 20 mA DC, load: 500 Ω max., resolution: approx. 10,000
<b>Auxiliary outputs</b>	<b>Number of outputs</b>	1 or 2 max. (Depends on the model.)
	<b>Output specifications</b>	Relay output: SPST-NO, 250 VAC, 2 A (resistive load), electrical life: 100,000 operations, minimum applicable load: 5 V, 10 mA
<b>Event inputs</b>	<b>Number of inputs</b>	2
	<b>External contact input specifications</b>	Contact input: ON: 1 kΩ max., OFF: 100 kΩ min.
		Non-contact input: ON: Residual voltage: 1.5 V max., OFF: Leakage current: 0.1 mA max. Current flow: Approx. 7 mA per contact
<b>Setting method</b>	Digital setting using front panel keys	
<b>Indication method</b>	11-segment digital display and individual indicators (7-segment display also possible) Character height: PV: 7.5 mm, SV: 3.6 mm	
<b>Multi SP</b>	Up to four set points (SP0 to SP3) can be saved and selected using event inputs, key operations, or serial communications.	
<b>Bank switching</b>	Not supported	
<b>Other functions</b>	Manual output, heating/cooling control, loop burnout alarm, SP ramp, other alarm functions, heater burnout detection, 40% AT, 100% AT, MV limiter, input digital filter, self-tuning, temperature input shift, run/stop, protection functions, control output ON/OFF counter, extraction of square root, MV change rate limit, logic operations, PV/SV status display, simple program, automatic cooling coefficient adjustment	
<b>Ambient operating temperature</b>	-10 to 55°C (with no condensation or icing), for 3-year warranty: -10 to 50°C	
<b>Ambient operating humidity</b>	25% to 85%	
<b>Storage temperature</b>	-25 to 65°C (with no condensation or icing)	

# Input Ranges

## Thermocouple/Platinum Resistance Thermometer (Universal Inputs)

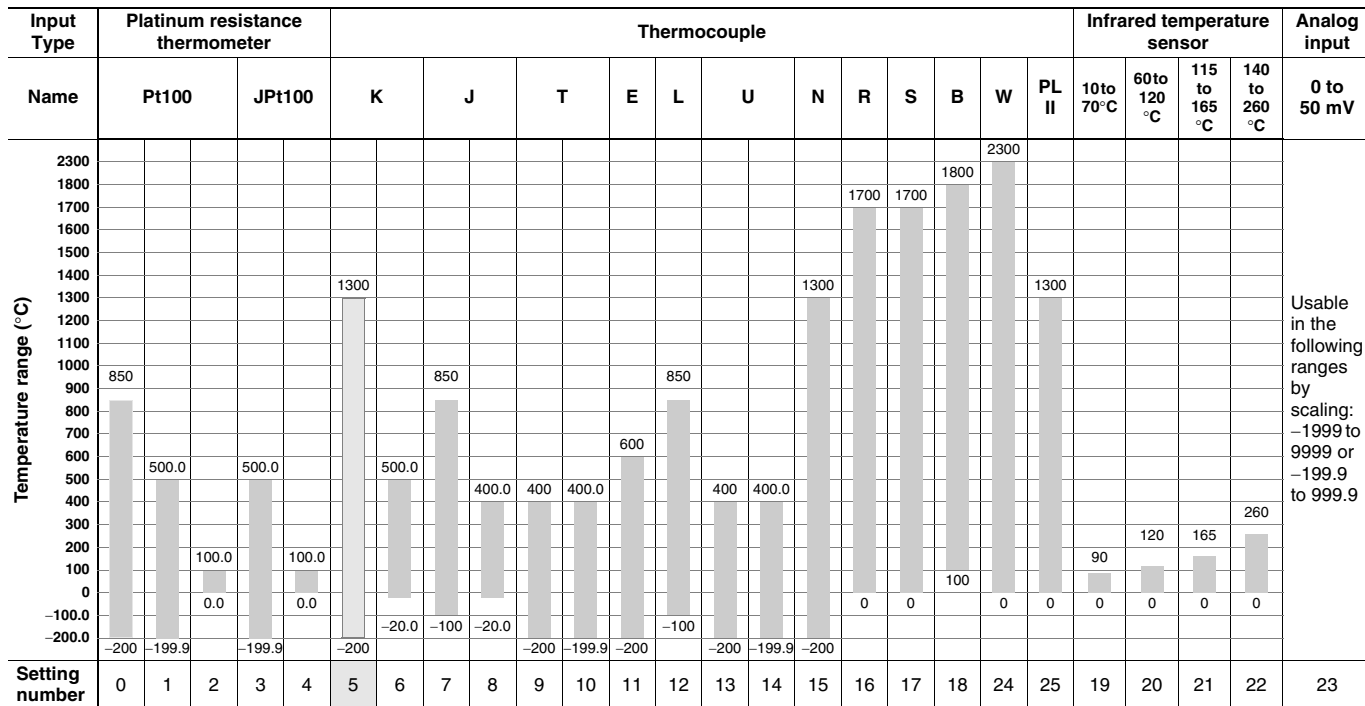

Shaded settings are the default settings.

The applicable standards for the input types are as follows:

K, J, T, E, N, R, S, B: JIS C 1602-1995, IEC 584-1

L: Fe-CuNi, DIN 43710-1985

U: Cu-CuNi, DIN 43710-1985

W: W5Re/W26Re, ASTM E988-1990

JPt100: JIS C 1604-1989, JIS C 1606-1989

Pt100: JIS C 1604-1997, IEC 751

PL II: According to Platinel II electromotive force charts from BASF (previously Engelhard)

### Models with Analog Inputs

Input Type	Current		Voltage		
Input specification	4 to 20 mA	0 to 20 mA	1 to 5 V	0 to 5 V	0 to 10 V
Setting range	Usable in the following ranges by scaling: -1999 to 9999, -199.9 to 999.9, -19.99 to 99.99 or -1.999 to 9.999				
Setting number	0	1	2	3	4

Shaded settings are the default settings.

## Alarm Outputs

Each alarm can be independently set to one of the following 13 alarm types. The default is 2: *Upper limit*. Auxiliary outputs are allocated for alarms. ON delays and OFF delays (0 to 999 s) can also be specified.

**Note:** For models with heater burnout, SSR failure, and heater overcurrent detection, alarm 1 will be an OR output of the alarm selected from the following alarm types and the alarms for heater burnout, SSR failure, and heater overcurrent. To output only a heater burnout alarm, SSR failure alarm, and heater overcurrent alarm for alarm 1, set the alarm type to 0 (i.e., no alarm function).

Set value	Alarm type	Alarm output operation		Description of function
		When alarm value X is positive	When alarm value X is negative	
0	Alarm function OFF	Output OFF		No alarm
1 <sup>*1</sup>	Upper- and lower-limit		<sup>*2</sup>	Set the deviation in the set point by setting the alarm upper limit (H) and alarm lower limit (L).
2	Upper-limit			Set the upward deviation in the set point by setting the alarm value (X).
3	Lower-limit			Set the downward deviation in the set point by setting the alarm value (X).
4 <sup>*1</sup>	Upper- and lower-limit range		<sup>*3</sup>	Set the deviation in the set point by setting the alarm upper limit (H) and alarm lower limit (L).
5 <sup>*1</sup>	Upper- and lower-limit with standby sequence		<sup>*4</sup>	A standby sequence is added to the upper- and lower-limit alarm (1). <sup>*6</sup>
6	Upper-limit with standby sequence			A standby sequence is added to the upper-limit alarm (2). <sup>*6</sup>
7	Lower-limit with standby sequence			A standby sequence is added to the lower-limit alarm (3). <sup>*6</sup>
8	Absolute-value upper-limit			The alarm will turn ON if the process value is larger than the alarm value (X) regardless of the set point.
9	Absolute-value lower-limit			The alarm will turn ON if the process value is smaller than the alarm value (X) regardless of the set point.
10	Absolute-value upper-limit with standby sequence			A standby sequence is added to the absolute-value upper-limit alarm (8). <sup>*6</sup>
11	Absolute-value lower-limit with standby sequence			A standby sequence is added to the absolute-value lower-limit alarm (9). <sup>*6</sup>
12	LBA (alarm 1 type only)	---		<sup>*7</sup>
13	PV change rate alarm	---		<sup>**8</sup>

<sup>\*1</sup>. With set values 1, 4 and 5, the upper and lower limit values can be set independently for each alarm type, and are expressed as "L" and "H."

<sup>\*2</sup>. Set value: 1, Upper- and lower-limit alarm

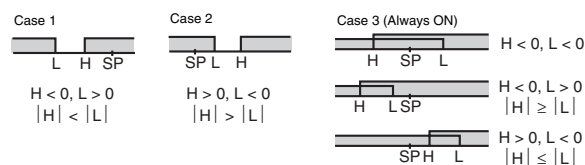

<sup>\*3</sup>. Set value: 4, Upper- and lower-limit range

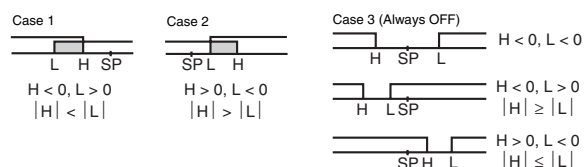

<sup>\*4</sup>. Set value: 5, Upper- and lower-limit with standby sequence

For Upper- and Lower-Limit Alarm Described Above

- Case 1 and 2  
Always OFF when the upper-limit and lower-limit hysteresis overlaps.
- Case 3: Always OFF

<sup>\*5</sup>. Set value: 5, Upper- and lower-limit with standby sequence

Always OFF when the upper-limit and lower-limit hysteresis overlaps.

<sup>\*6</sup>. Refer to the *E5CN/E5AN/E5EN/E5GN Digital Temperature Controllers User's Manual Basic Type* (Cat. No. H156) for information on the operation of the standby sequence.

<sup>\*7</sup>. Refer to the *E5CN/E5AN/E5EN/E5GN Digital Temperature Controllers User's Manual Basic Type* (Cat. No. H156) for information on the loop burnout alarm (LBA).

<sup>\*8</sup>. Refer to the *E5CN/E5AN/E5EN/E5GN Digital Temperature Controllers User's Manual Basic Type* (Cat. No. H156) for information on the PV change rate alarm.



## Characteristics

<b>Indication accuracy</b>	Thermocouple: <sup>1</sup> (±0.3% of indicated value or ±1°C, whichever is greater) ±1 digit max. Platinum resistance thermometer input: (±0.2% of indicated value or ±0.8°C, whichever is greater) ±1 digit max. Analog input: ±0.2% FS ±1 digit max. CT input: ±5% FS ±1 digit max.	
<b>Influence of temperature<sup>2</sup></b>	Thermocouple input (R, S, B, W, PL II): (±1% of PV or ±10°C, whichever is greater) ±1 digit max. Other thermocouple input: <sup>3</sup> (±1% of PV or ±4°C, whichever is greater) ±1 digit max.	
<b>Influence of voltage<sup>2</sup></b>	Platinum resistance thermometer input: (±1% of PV or ±2°C, whichever is greater) ±1 digit max. Analog input: (±1%FS) ±1 digit max.	
<b>Input sampling period</b>	250 ms	
<b>Hysteresis</b>	Models with thermocouple/platinum resistance thermometer input (universal input): 0.1 to 999.9 EU (in units of 0.1 EU) <sup>4</sup> Models with analog input: 0.01 to 99.99% FS (in units of 0.01% FS)	
<b>Proportional band (P)</b>	Models with thermocouple/platinum resistance thermometer input (universal input): 0.1 to 999.9 EU (in units of 0.1 EU) <sup>4</sup> Models with analog input: 0.1 to 999.9% FS (in units of 0.1% FS)	
<b>Integral time (I)</b>	0 to 3999 s (in units of 1 s)	
<b>Derivative time (D)</b>	0 to 3999 s (in units of 1 s) <sup>5</sup>	
<b>Control period</b>	0.5, 1 to 99 s (in units of 1 s)	
<b>Manual reset value</b>	0.0 to 100.0% (in units of 0.1%)	
<b>Alarm setting range</b>	-1999 to 9999 (decimal point position depends on input type)	
<b>Affect of signal source resistance</b>	Thermocouple: 0.1°C/Ω max. (100 Ω max.) Platinum resistance thermometer: 0.1°C/Ω max. (10 Ω max.)	
<b>Insulation resistance</b>	20 MΩ min. (at 500 VDC)	
<b>Dielectric strength</b>	2,300 VAC, 50 or 60 Hz for 1 min (between terminals with different charge)	
<b>Vibration resistance</b>	<b>Malfunction</b>	10 to 55 Hz, 20 m/s <sup>2</sup> for 10 min each in X, Y, and Z directions
	<b>Destruction</b>	10 to 55 Hz, 0.75-mm single amplitude for 2 hrs each in X, Y, and Z directions
<b>Shock resistance</b>	<b>Malfunction</b>	100 m/s <sup>2</sup> , 3 times each in X, Y, and Z directions
	<b>Destruction</b>	300 m/s <sup>2</sup> , 3 times each in X, Y, and Z directions
<b>Weight</b>	Controller: Approx. 90 g, Mounting Bracket: Approx. 10 g	
<b>Degree of protection</b>	Front panel: IP66, Rear case: IP20, Terminals: IP00	
<b>Memory protection</b>	Non-volatile memory (number of writes: 1,000,000 times)	
<b>Setup Tool</b>	CX-Thermo version 4.2 or higher	
<b>Setup Tool port</b>	Provided on the side of the E5GN. Connect this port to the computer when using the Setup Tool. An E58-CIFQ1 USB-Serial Conversion Cable is required to connect the computer to the port on the side of the E5GN. <sup>6</sup>	
<b>Standards</b>	<b>Approved standards</b>	UL 61010-1, CSA C22.2 No. 1010-1
	<b>Conformed standards</b>	EN 61010-1 (IEC 61010-1): Pollution level 2, overcurrent category II
<b>EMC</b>	EMI: Radiated Interference Electromagnetic Field Strength: EN 61326 Noise Terminal Voltage: EN 55011 Group 1, class A EMS: EN 61326 ESD Immunity: EN 61000-4-2 Electromagnetic Field Immunity: EN 61000-4-3 Burst Noise Immunity: EN 61000-4-4 Conducted Disturbance Immunity: EN 61000-4-6 Surge Immunity: EN 61000-4-5 Power Frequency Magnetic Field Immunity: EN 61000-4-8 Voltage Dip/Interrupting Immunity: EN 61000-4-11	

<sup>1</sup>. The indication accuracy of K thermocouples in the -200 to 1300°C range, T and N thermocouples at a temperature of -100°C max., and U and L thermocouples at any temperatures is ±2°C ±1 digit max. The indication accuracy of the B thermocouple at a temperature of 400°C max. is not specified. The indication accuracy of B thermocouples in the 400 to 800°C range is ±3°C max. The indication accuracy of the R and S thermocouples at a temperature of 200°C max. is ±3°C ±1 digit max. The indication accuracy of W thermocouples is ±0.3 of PV or ±3°C, whichever is greater, ±1 digit max. The indication accuracy of PL II thermocouples is ±0.3 of PV or ±2°C, whichever is greater, ±1 digit max.

<sup>2</sup>. Ambient temperature: -10°C to 23°C to 55°C, Voltage range: -15% to 10% of rated voltage

<sup>3</sup>. K thermocouple at -100°C max.: ±10° max.

<sup>4</sup>. "EU" stands for Engineering Unit and is used as the unit after scaling. For a temperature sensor, the EU is °C or °F.

<sup>5</sup>. When robust tuning (RT) is ON, the differential time is 0.0 to 999.9 (in units of 0.1 s).

<sup>6</sup>. External serial communications (RS-232C or RS-485) and cable communications for the Setup Tool can be used at the same time.

## USB-Serial Conversion Cable

Applicable OS	Windows 2000, XP, or Vista
Applicable software	CX-Thermo version 4 or higher
Applicable models	E5AN/E5EN/E5CN/E5CN-U/E5AN-H/ E5EN-H/E5CN-H/E5GN
USB interface standard	Conforms to USB Specification 1.1.
DTE speed	38400 bps
Connector specifications	Computer: USB (type A plug) Temperature Controller: Setup Tool port (on bottom of Controller)
Power supply	Bus power (Supplied from USB host controller.)
Power supply voltage	5 VDC
Current consumption	70 mA
Ambient operating temperature	0 to 55°C (with no condensation or icing)
Ambient operating humidity	10% to 80%
Storage temperature	-20 to 60°C (with no condensation or icing)
Storage humidity	10% to 80%
Altitude	2,000 m max.
Weight	Approx. 100 g

**Note:** A driver must be installed in the personal computer. Refer to installation information in the operation manual for the Conversion Cable.

## Communications Specifications

Transmission line connection method	RS-485: Multipoint RS-232C: Point-to-point
Communications	RS-485 (two-wire, half duplex), RS-232C
Synchronization method	Start-stop synchronization
Protocol	CompoWay/F, SYSWAY, or Modbus
Baud rate	1200, 2400, 4800, 9600, 19200, 38400, or 57600 bps
Transmission code	ASCII
Data bit length*	7 or 8 bits
Stop bit length*	1 or 2 bits
Error detection	Vertical parity (none, even, odd) Frame check sequence (FCS) with SYSWAY Block check character (BCC) with CompoWay/F or CRC-16 Modbus
Flow control	None
Interface	RS-485, RS-232C
Retry function	None
Communications buffer	217 bytes
Communications response wait time	0 to 99 ms Default: 20 ms

\* The baud rate, data bit length, stop bit length, and vertical parity can be individually set using the Communications Setting Level.

## Current Transformer (Order Separately) Ratings

Dielectric strength	1,000 VAC for 1 min
Vibration resistance	50 Hz, 98 m/s <sup>2</sup>
Weight	E54-CT1: Approx. 11.5 g, E54-CT3: Approx. 50 g
Accessories (E54-CT3 only)	Armatures (2) Plugs (2)

## Heater Burnout Alarms, SSR Failure Alarms, and Heater Overcurrent Alarms

CT input (for heater current detection)	Models with detection for single-phase heaters: One input
Maximum heater current	50 A AC
Input current indication accuracy	±5% FS ±1 digit max.
Heater burnout alarm setting range <sup>1</sup>	0.1 to 49.9 A (in units of 0.1 A) Minimum detection ON time: 100 ms
SSR failure alarm setting range <sup>2</sup>	0.1 to 49.9 A (in units of 0.1 A) Minimum detection OFF time: 100 ms
Heater overcurrent alarm setting range <sup>3</sup>	0.1 to 49.9 A (in units of 0.1 A) Minimum detection ON time: 100 ms

- For heater burnout alarms, the heater current will be measured when the control output is ON, and the output assigned to the alarm 1 function will turn ON if the heater current is lower than the set value (i.e., heater burnout detection current value).
- For SSR failure alarms, the heater current will be measured when the control output is OFF, and the output assigned to the alarm 1 function will turn ON if the heater current is higher than the set value (i.e., SSR failure detection current value).
- For heater overcurrent alarms, the heater current will be measured when the control output is ON, and the output assigned to the alarm 1 function will turn ON if the heater current is higher than the set value (i.e., heater overcurrent detection current value).

## Electrical Life Expectancy Curve for Relays (Reference Values)

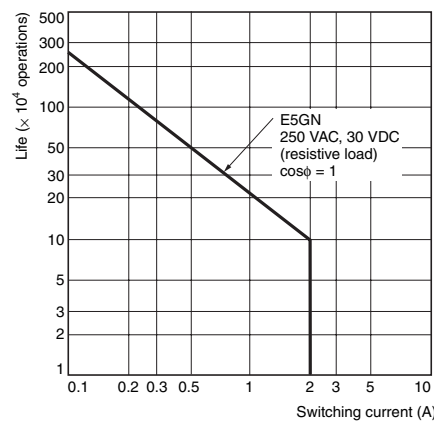

# External Connections

- A voltage output (control output, for driving SSR) is not electrically insulated from the internal circuits. When using a grounding thermocouple, do not connect any of the control output terminals to

ground. (If the control output terminals are connected to ground, errors will occur in the measured temperature values as a result of leakage current.)

## E5GN

## Controllers

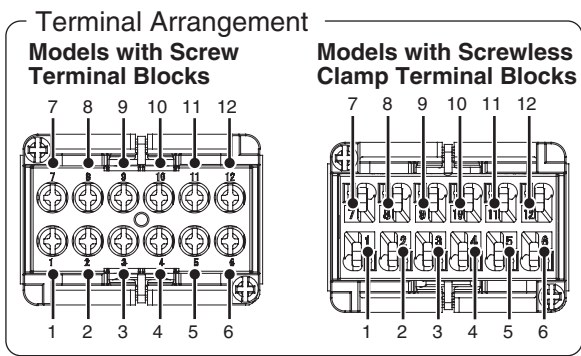
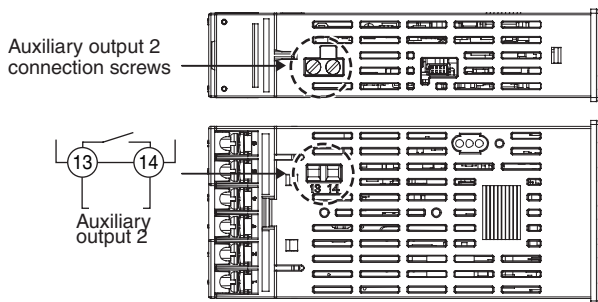
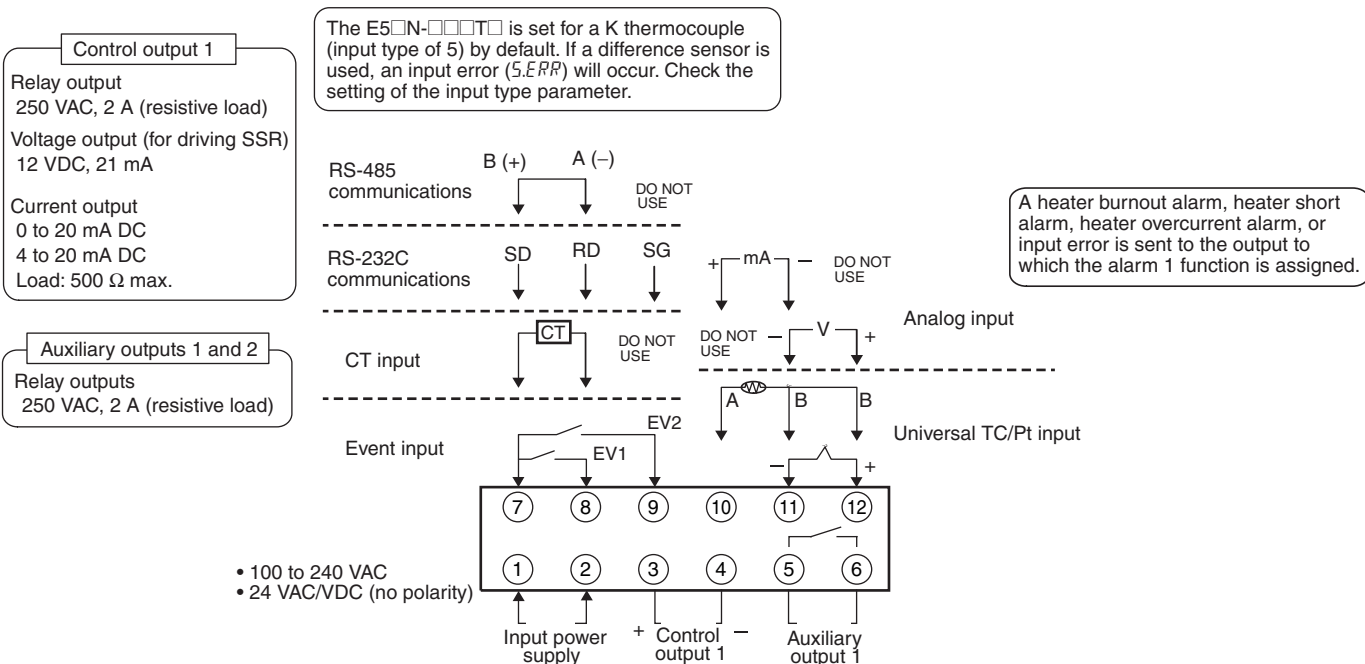

## Wiring

### E5GN

#### Models with Screw Terminal Blocks (M3 Screws)

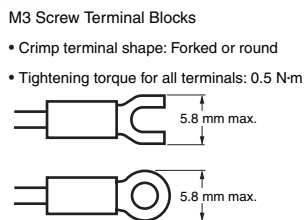
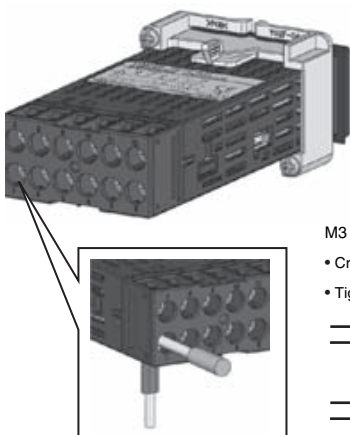

### E5GN-□-C

#### Models with Screwless Clamp Terminal Blocks

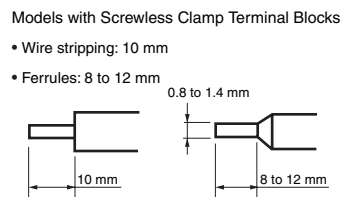
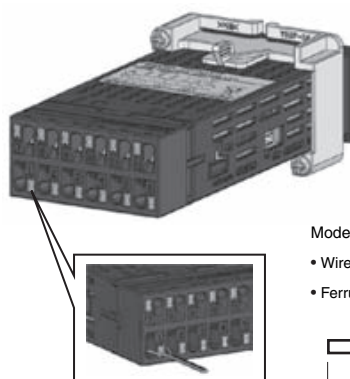

# Nomenclature

## E5GN

The front panel is the same for the E5GN.

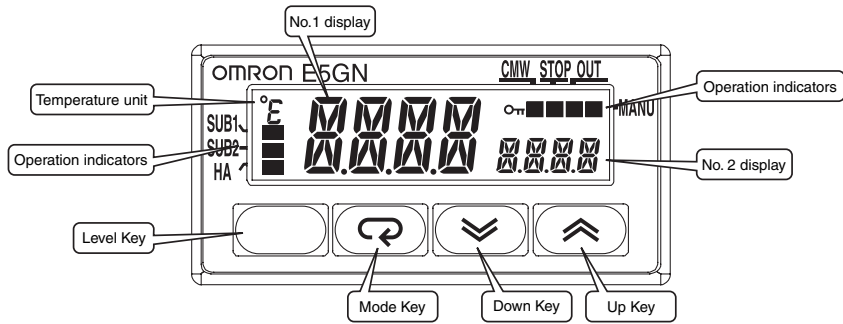

## Dimensions

(Unit: mm)

### E5GN Models with Screw Terminal Blocks

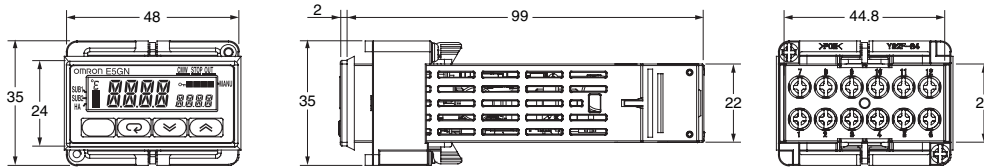

#### Panel Cutout

Mounted Separately

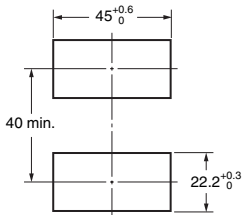

Group Mounted

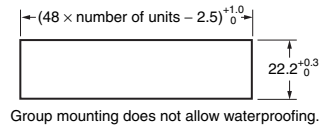

- Recommended panel thickness is 1 to 5 mm.
- Group mounting is not possible in the vertical direction. (Maintain the specified mounting space between Controllers.)
- To mount the Controller so that it is waterproof, insert the waterproof packing onto the Controller.
- When two or more Controllers are mounted, make sure that the surrounding temperature does not exceed the allowable operating temperature specified in the specifications.

### E5GN-□-C Models with Screwless Clamp Terminal Blocks

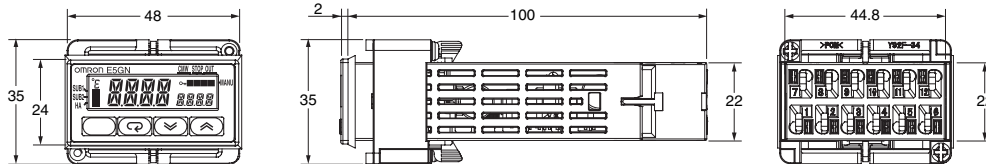

#### Panel Cutout

Mounted Separately

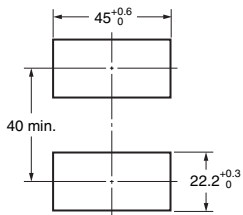

Group Mounted

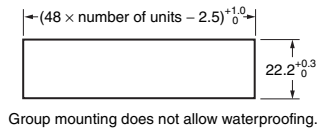

- Recommended panel thickness is 1 to 5 mm.
- Group mounting is not possible in the vertical direction. (Maintain the specified mounting space between Controllers.)
- When two or more Controllers are mounted, make sure that the surrounding temperature does not exceed the allowable operating temperature specified in the specifications.

## Accessories (Order Separately)

### USB-Serial Conversion Cable E58-CIFQ1

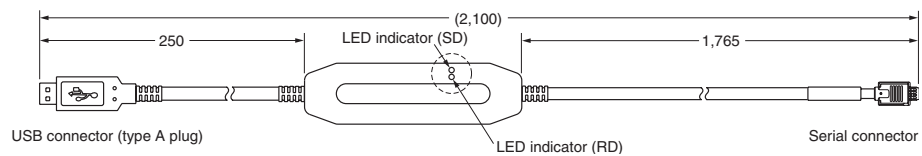
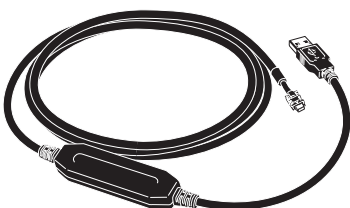

**Waterproof Packing**  
Y92S-32 (for DIN 48 × 24)

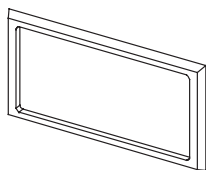

Order the Waterproof Packing separately if it becomes lost or damaged.  
The Waterproof Packing can be used to achieve an IP66 degree of protection. (Deterioration, shrinking, or hardening of the waterproof packing may occur depending on the operating environment. Therefore, periodic replacement is recommended to ensure the level of waterproofing specified in IP66. The time for periodic replacement depends on the operating environment. Be sure to confirm this point at your site. Consider one year a rough standard. OMRON shall not be liable for the level of water resistance if the customer does not perform periodic replacement.)  
The Waterproof Packing does not need to be attached if a waterproof structure is not required.

**Current Transformers**

**E54-CT1**

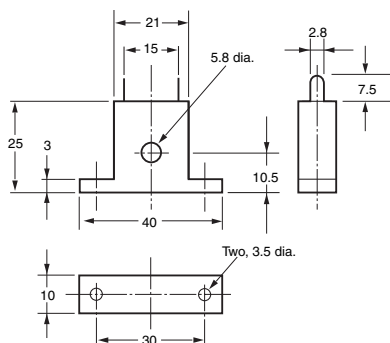
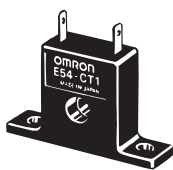

**E54-CT1**

**Thru-current (I<sub>o</sub>) vs. Output Voltage (E<sub>o</sub>) (Reference Values)**

Maximum continuous heater current: 50 A (50/60 Hz)  
Number of windings: 400±2  
Winding resistance: 18±2 Ω

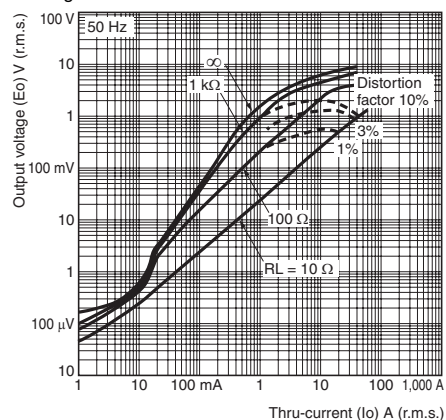

**E54-CT3**

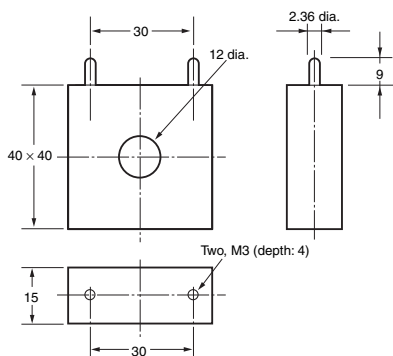

**E54-CT3**

**Thru-current (I<sub>o</sub>) vs. Output Voltage (E<sub>o</sub>) (Reference Values)**

Maximum continuous heater current for the Temperature Controller is 50 A.  
Number of windings: 400±2  
Winding resistance: 8±0.8 Ω

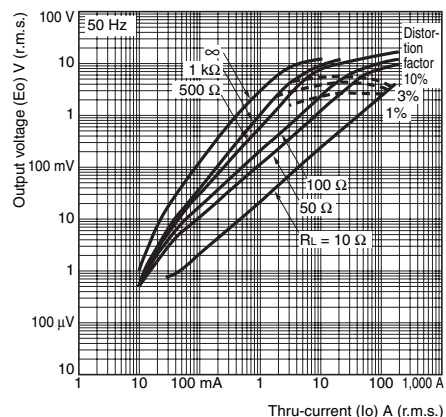

**E54-CT3 Accessory**

- Armature

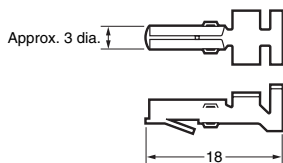

- Plug

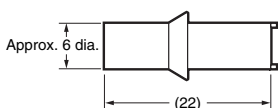

**Connection Example**

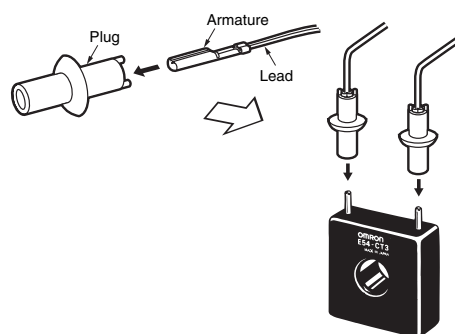

## Mounting to the Panel

- For waterproof mounting, waterproof packing must be installed on the Controller. Waterproofing is not possible when group mounting several Controllers. Waterproof packing is not necessary when there is no need for the waterproofing function.
- Insert the E5GN into the mounting hole in the panel.
- Push the adapter from the terminals up to the panel, and temporarily fasten the E5GN.
- Tighten the two fastening screws on the adapter. Alternately tighten the two screws little by little to maintain a balance. Tighten the screws to a torque of 0.29 to 0.39 N·m.

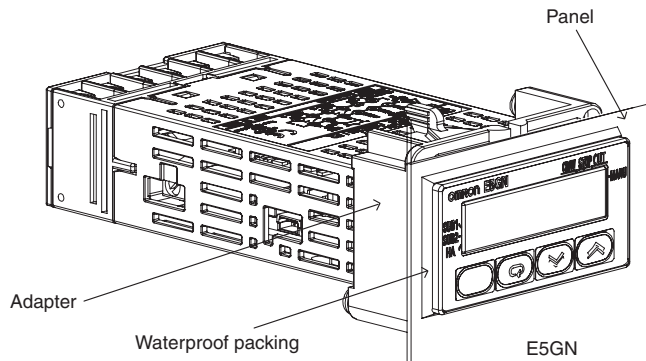

## Removing the Terminal Block

The terminal block can be removed from the E5GN. The body of the Controller can be replaced by removing the terminal block from the E5GN.

- Insert a flat-blade screwdriver into the tool holes (one on the top and one on the bottom) to release the hooks. Do not apply excessive force.

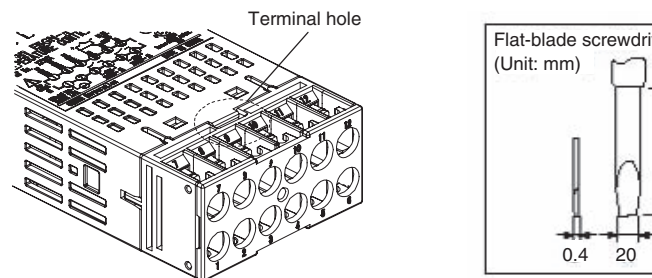

- Pull the terminal block out while the hooks are released.

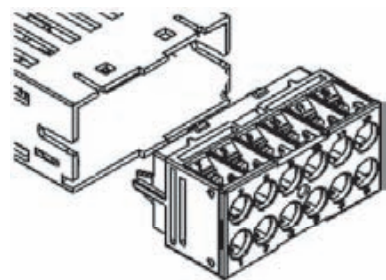

**Note:** The method for removing the terminal block is the same for both screw terminal blocks and screwless clamp terminal blocks.

Do not connect a different type of terminal block to a Controller. For example, do not replace a screw terminal block with a screwless clamp terminal block. The temperature indication accuracy will decrease.

## Precautions when Wiring

- Separate input leads and power lines in order to prevent external noise.
- Use a shielded, AWG24 to AWG18 (cross-sectional area of 0.205 to 0.823 mm<sup>2</sup>) twisted-pair cable for the E5GN. The stripping length is 6 to 8 mm.
- Use crimp terminals when wiring the terminals.
- Use the suitable wiring material and crimp tools for crimp terminals.
- Tighten the terminal screws to a torque of 0.5 N·m for the E5GN. The terminal torque is 0.5 to 0.6 N·m for auxiliary output 2 on the E5GN.
- For the E5GN, use the following types of crimp terminals for M3.0 screws.



- For E5GN screwless clamp terminal blocks, use wires with a gauge of AWG24 to AWG18 (equal to a cross-sectional area of 0.205 to 0.823 mm<sup>2</sup>). The length of the conductive portion inserted into the terminal must be 10 mm for wires and 8 to 12 mm for ferrules. Ferrules must be 0.8 to 1.4 mm in diameter.

0.8 to 1.4 mm

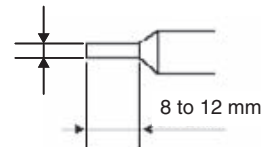

Ferrules

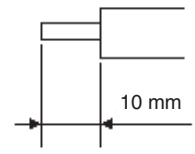

wires

- Recommended Ferrules for E5GN Screwless Clamp Terminals

Manufacturer		Model number
Altech Corp.		2623.0
Daido Solderless Terminal Mfg. Co.		AVA-0.5
J.S.T. Mfg. Co.		TUB-0.5
Nichifu Co.	Single (1 wire)	TGNTC-1.25-9T TGVTC-1.25-11T TGNTC-1.25-11T TC0.3-9.5 TC1.25-11S-ST TC1.25-11S TC2-11S
	Double (2 wires)	TGWVTC-1.25-9T TGWVTC-1.25-11T

- Use wires with a gauge of AWG24 to AWG18 (0.205 to 0.823 mm<sup>2</sup>) for auxiliary output 2 on the E5GN. The exposed conductor length inserted into the terminal for wires or ferrules must be 6 mm. Ferrules must be 0.8 to 1.5 mm in diameter.

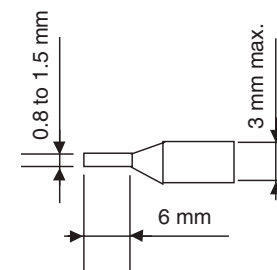

Ferrules

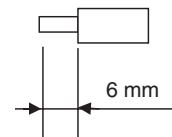

Wires

- Recommended Ferrules for SUB2 on E5GN

Manufacturer	Model number
Phoenix Contact	AI 0,25-6 BU
	AI 0,34-6 TQ
	AI 0,5-6 WH
	AI 0,75-6 GY
	AI 1-6 RD

# Operation

## Setting Levels Diagram

This diagram shows all of the setting levels. To move to the advanced function setting level and calibration level, you must enter passwords. Some parameters are not displayed depending on the protect level setting and the conditions of use. Control stops when you move from the operation level to the initial setting level.

### Basic Type

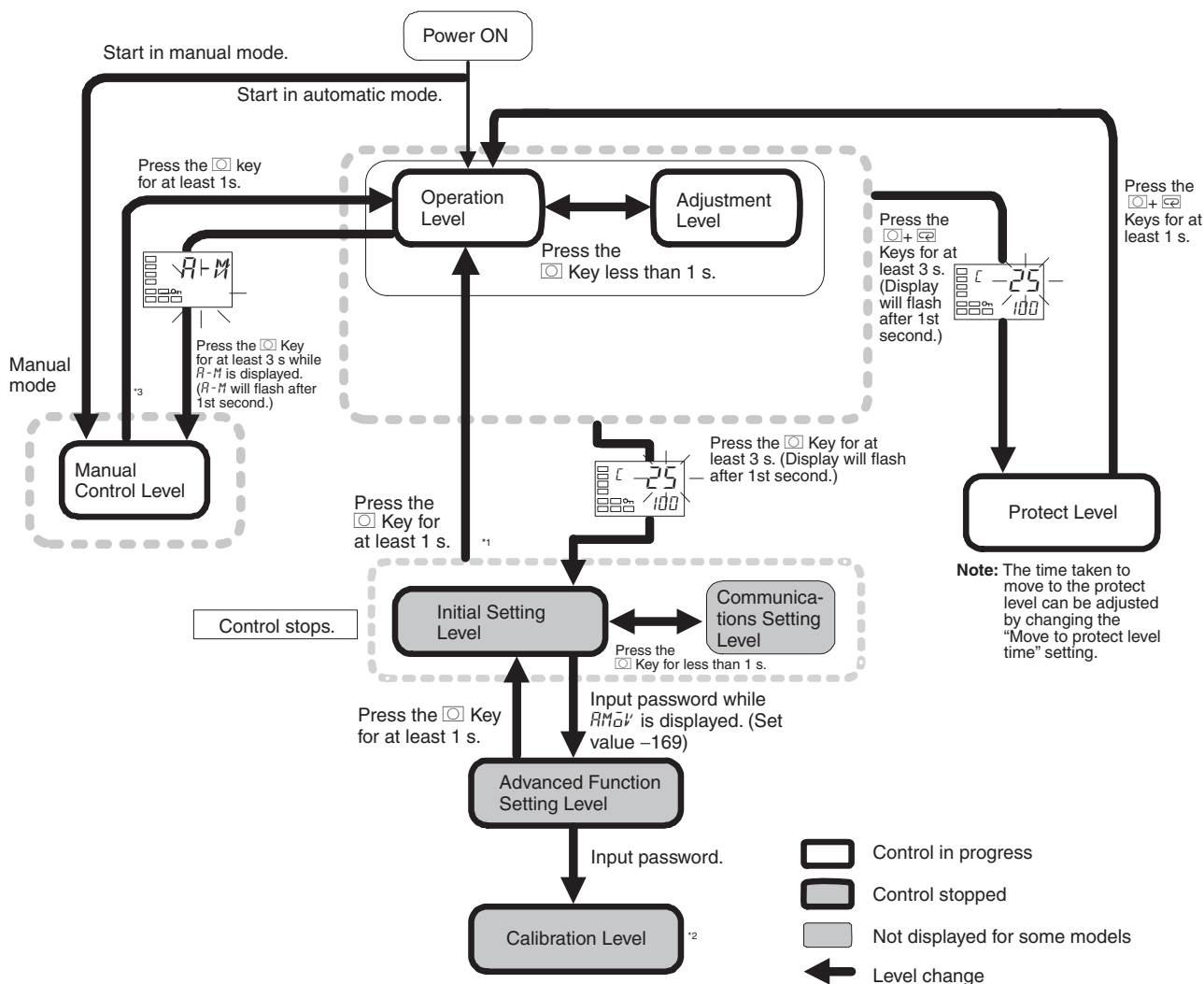

- \*1. You can return to the operation level by executing a software reset.
- \*2. It is not possible to move to other levels from the calibration level by operating the keys on the front panel. It can be done only by first turning OFF the power.
- \*3. From the manual control level, key operations can be used to move to the operation level only.

## Error Displays (Troubleshooting)

When an error occurs, the No.1 display shows the error code. Take necessary measure according to the error code, referring the table below.

No.1 display	Meaning	Action	Status at error	
			Control output	Alarm output
S.ERR (S. Err)	Input error*	Check the wiring of inputs for miswiring, disconnections, and short-circuits and check the input type.	OFF	Operates as above the upper limit.
E333 (E333)	A/D converter error	Turn the power OFF then back ON again. If the display remains the same, the controller must be repaired. If the display is restored to normal, then a probable cause can be external noise affecting the control system. Check for external noise.	OFF	OFF
E111 (E111)	Memory error	Turn the power OFF then back ON again. If the display remains the same, the controller must be repaired. If the display is restored to normal, then a probable cause can be external noise affecting the control system. Check for external noise.	OFF	OFF

**Note:** If the input value exceeds the display limit (-1999 to 9999), though it is within the control range, [ ] will be displayed under -1999 and [ ] above 9999. Under these conditions, control output and alarm output will operate normally. For details on the control range, refer to the *E5CN/E5EN/E5AN/E5GN Digital Temperature Controllers User's Manual Basic Type* (Cat. No. H156).

\* These errors are displayed only when the PV/SP is displayed. Errors are not displayed for other displays.

# Parameters

## Basic Type

Some parameters are not displayed depending on the model of the Controller and parameter settings. For details, refer to the *E5CN/E5EN/E5AN/E5GN Digital Temperature Controllers User's Manual Basic Type* (Cat. No. H156).

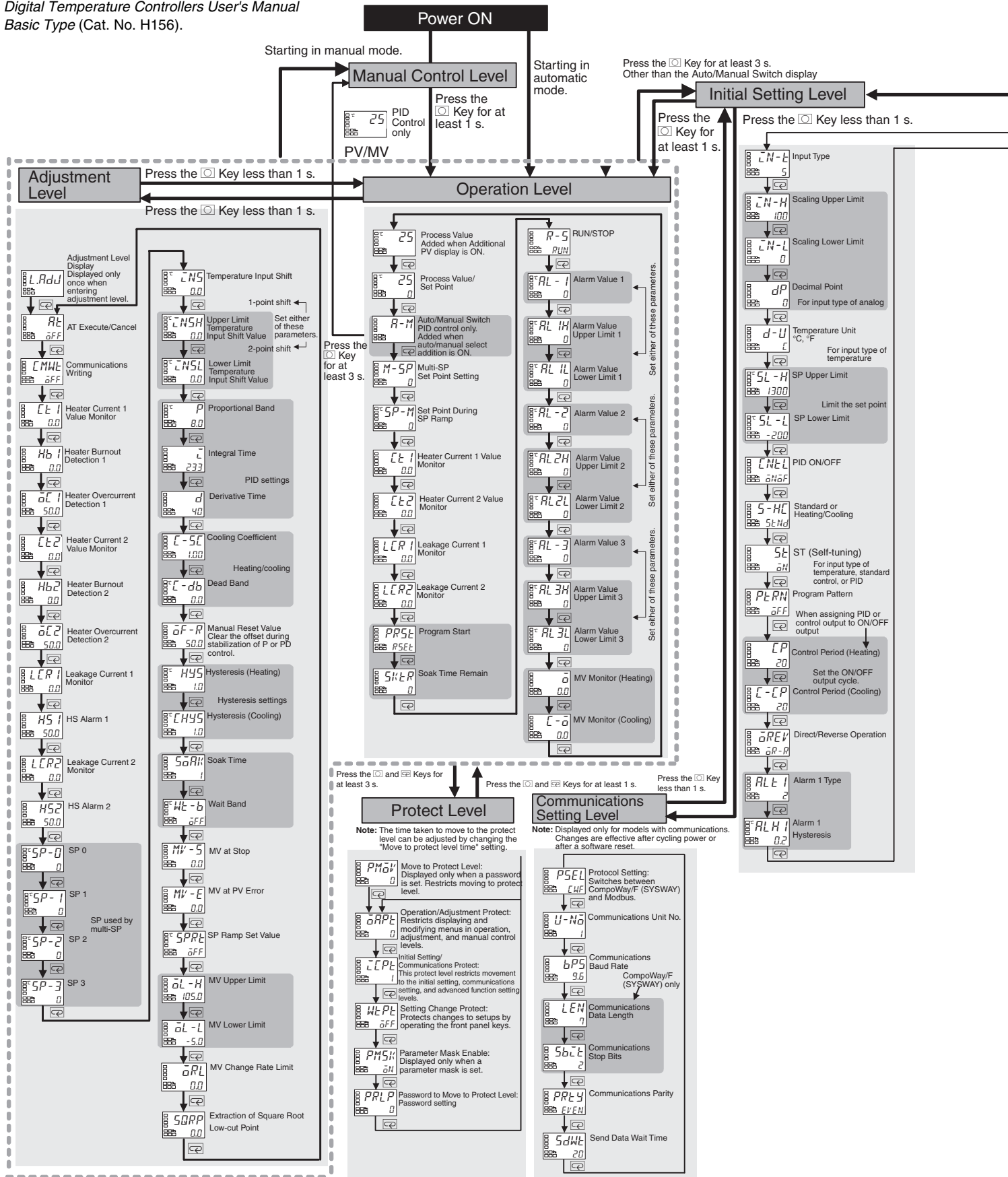



Press the  Key for at least 1 s.

Advanced Function Setting Level

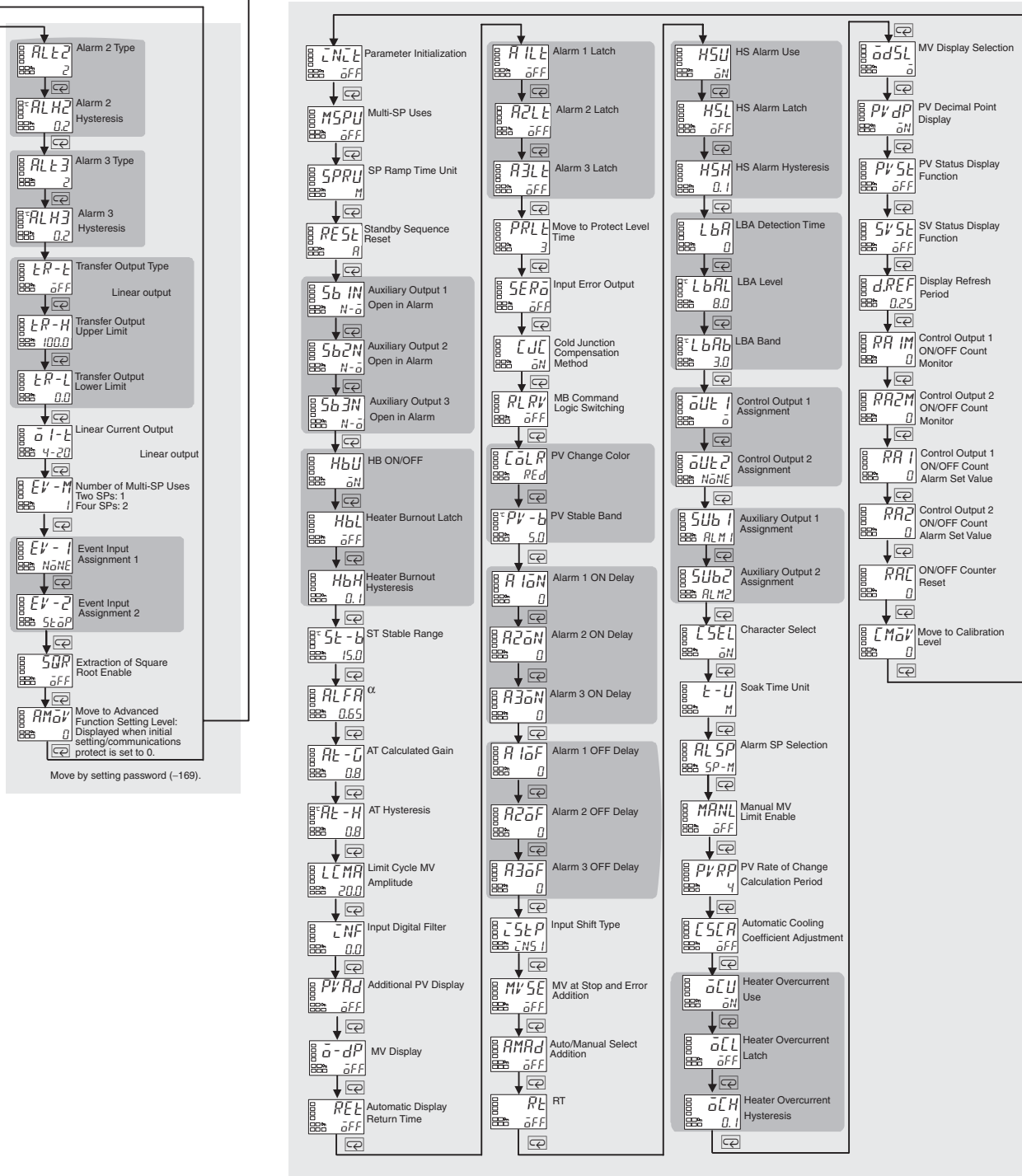

## Safety Precautions

Do not touch the terminals while power is being supplied. Doing so may occasionally result in minor injury due to electric shock.



Do not allow pieces of metal, wire clippings, or fine metallic shavings or filings from installation to enter the product. Doing so may occasionally result in electric shock, fire, or malfunction.



Do not use the product where subject to flammable or explosive gas. Otherwise, minor injury from explosion may occasionally occur.



Do not leave the cable for the Support Software connected to the product. Malfunction may occur due to noise in the cable.



Do not use the Temperature Controller or Conversion Cable if it is damaged. Doing so may occasionally result in minor electric shock or fire.



Never disassemble, modify, or repair the product or touch any of the internal parts. Minor electric shock, fire, or malfunction may occasionally occur.



### CAUTION - Risk of Fire and Electric Shock

- a) This product is UL listed as Open Type Process Control Equipment. It must be mounted in an enclosure that does not allow fire to escape externally.
- b) More than one disconnect switch may be required to de-energize the equipment before servicing the product.
- c) Signal inputs are SELV, limited energy.\*<sup>1</sup>
- d) Caution: To reduce the risk of fire or electric shock, do not interconnect the outputs of different Class 2 circuits.\*<sup>2</sup>



If the output relays are used past their life expectancy, contact fusing or burning may occasionally occur. Always consider the application conditions and use the output relays within their rated load and electrical life expectancy. The life expectancy of output relays varies considerably with the output load and switching conditions.



Tighten the terminal screws to between 0.74 and 0.90 N·m. Loose screws may occasionally result in fire.



Set the parameters of the product so that they are suitable for the system being controlled. If they are not suitable, unexpected operation may occasionally result in property damage or accidents.



A malfunction in the product may occasionally make control operations impossible or prevent alarm outputs, resulting in property damage. To maintain safety in the event of malfunction of the product, take appropriate safety measures, such as installing a monitoring device on a separate line.



A semiconductor is used in the output section of long-life relays. If excessive noise or surge is impressed on the output terminals, a short-circuit failure is likely to occur. If the output remains shorted, fire will occur due to overheating of the heater or other cause. Take measures in the overall system to prevent excessive temperature increase and to prevent fire from spreading.



Do not allow pieces of metal or wire cuttings to get inside the cable connector for the Support Software. Failure to do so may occasionally result in minor electric shock, fire, or damage to equipment.



Do not allow dust and dirt to collect between the pins in the connector on the Conversion Cable. Failure to do so may occasionally result in fire.



When inserting the body of the Temperature Controller into the case, confirm that the hooks on the top and bottom are securely engaged with the case. If the body of the Temperature Controller is not inserted properly, faulty contact in the terminal section or reduced water resistance may occasionally result in fire or malfunction.



When connecting the Control Output Unit to the socket, press it in until there is no gap between the Control Output Unit and the socket. Otherwise contact faults in the connector pins may occasionally result in fire or malfunction.



\* 1. An SELV circuit is one separated from the power supply with double insulation or reinforced insulation, that does not exceed 30 V r.m.s. and 42.4 V peak or 60 VDC.

\* 2. A class 2 power supply is one tested and certified by UL as having the current and voltage of the secondary output restricted to specific levels.

## Precautions for Safe Use

Be sure to observe the following precautions to prevent malfunction or adverse affects on the performance or functionality of the product. Not doing so may occasionally result in faulty operation.

1. This product is specifically designed for indoor use only. Do not use this product in the following places:
  - Places directly subject to heat radiated from heating equipment.
  - Places subject to splashing liquid or oil atmosphere.
  - Places subject to direct sunlight.
  - Places subject to dust or corrosive gas (in particular, sulfide gas and ammonia gas).
  - Places subject to intense temperature change.
  - Places subject to icing and condensation.
  - Places subject to vibration and large shocks.
2. Use and store the product within the rated ambient temperature and humidity. Gang-mounting two or more Temperature Controllers, or mounting Temperature Controllers above each other may cause heat to build up inside the Temperature Controllers, which will shorten their service life. In such a case, use forced cooling by fans or other means of air ventilation to cool down the Temperature Controllers.
3. To allow heat to escape, do not block the area around the product. Do not block the ventilation holes on the product.
4. Be sure to wire properly with correct polarity of terminals.
5. Use the specified size (M3.5, width 7.2 mm or less) crimped terminals for wiring. To connect bare wires to the terminal block, use stranded or solid copper wires with a gage of AWG24 to AWG14 (equal to a cross-sectional area of 0.205 to 2.081 mm<sup>2</sup>). (The stripping length is 5 to 6 mm.) Up to two wires of the same size and type or two crimp terminals can be inserted into a single terminal.
6. Do not wire the terminals that are not used.
7. To avoid inductive noise, keep the wiring for the product's terminal block away from power cables carry high voltages or large currents. Also, do not wire power lines together with or parallel to product wiring. Using shielded cables and using separate conduits or ducts is recommended. Attach a surge suppressor or noise filter to peripheral devices that generate noise (in particular, motors, transformers, solenoids, magnetic coils, or other equipment that have an inductance component). When a noise filter is used at the power supply, first check the voltage or current, and attach the noise filter as close as possible to the product. Allow as much space as possible between the product and devices that generate powerful high frequencies (high-frequency welders, high-frequency sewing machines, etc.) or surge.
8. Use this product within the rated load and power supply.
9. Make sure that the rated voltage is attained within two seconds of turning ON the power using a switch or relay contact. If the voltage is applied gradually, the power may not be reset or output malfunctions may occur.
10. Make sure that the Temperature Controller has 30 minutes or more to warm up after turning ON the power before starting actual control operations to ensure the correct temperature display.

11. When executing self-tuning, turn ON power to the load (e.g., heater) at the same time as or before supplying power to the product. If power is turned ON to the product before turning ON power to the load, self-tuning will not be performed properly and optimum control will not be achieved.
12. A switch or circuit breaker must be provided close to the product. The switch or circuit breaker must be within easy reach of the operator, and must be marked as a disconnecting means for this unit.
13. Always turn OFF the power supply before pulling out the interior of the product, and never touch nor apply shock to the terminals or electronic components. When inserting the interior of the product, do not allow the electronic components to touch the case.
14. Do not use paint thinner or similar chemical to clean with. Use standard grade alcohol.
15. Design the system (e.g., control panel) considering the 2 seconds of delay that the product's output to be set after power ON.
16. The output may turn OFF when shifting to certain levels. Take this into consideration when performing control.
17. The number of EEPROM write operations is limited. Therefore, use RAM write mode when frequently overwriting data during communications or other operations.
18. Always touch a grounded piece of metal before touching the Temperature Controller to discharge static electricity from your body.
19. Do not remove the terminal block. Doing so may result in failure or malfunction.
20. Control outputs (for driving SSR) that are voltage outputs are not isolated from the internal circuits. When using a grounded thermocouple, do not connect any of the control output terminals to ground. (Doing so may result in an unwanted circuit path, causing error in the measured temperature.)
21. When replacing the body of the Temperature Controller, check the condition of the terminals. If corroded terminals are used, contact failure in the terminals may cause the temperature inside the Temperature Controller to increase, possibly resulting in fire. If the terminals are corroded, replace the case as well.
22. Use suitable tools when taking the Temperature Controller apart for disposal. Sharp parts inside the Temperature Controller may cause injury.
23. Before connecting an Output Unit, confirm the specifications and thoroughly read relevant information in the datasheet and manual for the Temperature Controller.
24. Check the orientation of the connectors on the Conversion Cable before connecting the Conversion Cable. Do not force a connector if it does not connect smoothly. Using excessive force may damage the connector.
25. Do not place heavy object on the Conversion Cable, bend the cable past its natural bending radius, or pull on the cable with undue force.
26. Do not connect or disconnect the Conversion Cable while communications are in progress. Product faults or malfunction may occur.
27. Make sure that the Conversion Cable's metal components are not touching the external power terminals.
28. Do not touch the connectors on the Conversion Cable with wet hands. Electrical shock may result.
29. Before using infrared communications, correctly attach the enclosed Mounting Adapter to the cable for the Support Software. When connecting the infrared port on the cable to the Support Software into the Adapter, insert the connector to the specified line. Communications may not be possible if the connector is not connected properly.

## Precautions for Correct Use

### Service Life

1. Use the product within the following temperature and humidity ranges:  
 Temperature: -10 to 55°C (with no icing or condensation)  
 Humidity: 25% to 85%  
 If the product is installed inside a control board, the ambient temperature must be kept to under 55°C, including the temperature around the product.
2. The service life of electronic devices like Temperature Controllers is determined not only by the number of times the relay is switched but also by the service life of internal electronic components. Component service life is affected by the ambient temperature: the higher the temperature, the shorter the service life and, the lower the temperature, the longer the service life. Therefore, the service life can be extended by lowering the temperature of the Temperature Controller.

3. When two or more Temperature Controllers are mounted horizontally close to each other or vertically next to one another, the internal temperature will increase due to heat radiated by the Temperature Controllers and the service life will decrease. In such a case, use forced cooling by fans or other means of air ventilation to cool down the Temperature Controllers. When providing forced cooling, however, be careful not to cool down the terminals sections alone to avoid measurement errors.

### Measurement Accuracy

1. When extending or connecting the thermocouple lead wire, be sure to use compensating wires that match the thermocouple types.
2. When extending or connecting the lead wire of the platinum resistance thermometer, be sure to use wires that have low resistance and keep the resistance of the three lead wires the same.
3. Mount the product so that it is horizontally level.
4. If the measurement accuracy is low, check to see if input shift has been set correctly.

### Waterproofing

The degree of protection is as shown below. Sections without any specification on their degree of protection or those with IP□0 are not waterproof.

Front panel: IP66

Rear case: IP20, Terminal section: IP00

### Operating Precautions

1. It takes approximately two seconds for the outputs to turn ON from after the power supply is turned ON. Due consideration must be given to this time when incorporating Temperature Controllers in a sequence circuit.
2. When using self-tuning, turn ON power for the load (e.g., heater) at the same time as or before supplying power to the Temperature Controller. If power is turned ON for the Temperature Controller before turning ON power for the load, self-tuning will not be performed properly and optimum control will not be achieved.
3. When starting operation after the Temperature Controller has warmed up, turn OFF the power and then turn it ON again at the same time as turning ON power for the load. (Instead of turning the Temperature Controller OFF and ON again, switching from STOP mode to RUN mode can also be used.)
4. Avoid using the Controller in places near a radio, television set, or wireless installing. These devices can cause radio disturbances which adversely affect the performance of the Controller.

### Others

1. The disk that is included with the Conversion Cable is designed for a computer CD-ROM driver. Never attempt to play the disk in a general-purpose audio player.
2. Do not connect or disconnect the Conversion Cable connector repeatedly over a short period of time. The computer may malfunction.
3. After connecting the Conversion Cable to the computer, check the COM port number before starting communications. The computer requires time to recognize the cable connection. This delay does not indicate failure.
4. Do not connect the Conversion Cable through a USB hub. Doing so may damage the Conversion Cable.
5. Do not use an extension cable to extend the Conversion Cable length when connecting to the computer. Doing so may damage the Conversion Cable.

# Warranty and Application Considerations

## Read and Understand This Catalog

Please read and understand this catalog before purchasing the products. Please consult your OMRON representative if you have any questions or comments.

## Warranty and Limitations of Liability

### WARRANTY

OMRON's exclusive warranty is that the products are free from defects in materials and workmanship for a period of one year (or other period if specified) from date of sale by OMRON.

OMRON MAKES NO WARRANTY OR REPRESENTATION, EXPRESS OR IMPLIED, REGARDING NON-INFRINGEMENT, MERCHANTABILITY, OR FITNESS FOR PARTICULAR PURPOSE OF THE PRODUCTS. ANY BUYER OR USER ACKNOWLEDGES THAT THE BUYER OR USER ALONE HAS DETERMINED THAT THE PRODUCTS WILL SUITABLY MEET THE REQUIREMENTS OF THEIR INTENDED USE. OMRON DISCLAIMS ALL OTHER WARRANTIES, EXPRESS OR IMPLIED.

### LIMITATIONS OF LIABILITY

OMRON SHALL NOT BE RESPONSIBLE FOR SPECIAL, INDIRECT, OR CONSEQUENTIAL DAMAGES, LOSS OF PROFITS, OR COMMERCIAL LOSS IN ANY WAY CONNECTED WITH THE PRODUCTS, WHETHER SUCH CLAIM IS BASED ON CONTRACT, WARRANTY, NEGLIGENCE, OR STRICT LIABILITY.

In no event shall the responsibility of OMRON for any act exceed the individual price of the product on which liability is asserted.

IN NO EVENT SHALL OMRON BE RESPONSIBLE FOR WARRANTY, REPAIR, OR OTHER CLAIMS REGARDING THE PRODUCTS UNLESS OMRON'S ANALYSIS CONFIRMS THAT THE PRODUCTS WERE PROPERLY HANDLED, STORED, INSTALLED, AND MAINTAINED AND NOT SUBJECT TO CONTAMINATION, ABUSE, MISUSE, OR INAPPROPRIATE MODIFICATION OR REPAIR.

## Application Considerations

### SUITABILITY FOR USE

OMRON shall not be responsible for conformity with any standards, codes, or regulations that apply to the combination of products in the customer's application or use of the products.

Take all necessary steps to determine the suitability of the product for the systems, machines, and equipment with which it will be used.

Know and observe all prohibitions of use applicable to this product.

NEVER USE THE PRODUCTS FOR AN APPLICATION INVOLVING SERIOUS RISK TO LIFE OR PROPERTY WITHOUT ENSURING THAT THE SYSTEM AS A WHOLE HAS BEEN DESIGNED TO ADDRESS THE RISKS, AND THAT THE OMRON PRODUCTS ARE PROPERLY RATED AND INSTALLED FOR THE INTENDED USE WITHIN THE OVERALL EQUIPMENT OR SYSTEM.

## Disclaimers

### PERFORMANCE DATA

Performance data given in this catalog is provided as a guide for the user in determining suitability and does not constitute a warranty. It may represent the result of OMRON's test conditions, and the users must correlate it to actual application requirements. Actual performance is subject to the OMRON *Warranty and Limitations of Liability*.

### CHANGE IN SPECIFICATIONS

Product specifications and accessories may be changed at any time based on improvements and other reasons. Consult with your OMRON representative at any time to confirm actual specifications of purchased product.

### DIMENSIONS AND WEIGHTS

Dimensions and weights are nominal and are not to be used for manufacturing purposes, even when tolerances are shown.

### ALL DIMENSIONS SHOWN ARE IN MILLIMETERS.

To convert millimeters into inches, multiply by 0.03937. To convert grams into ounces, multiply by 0.03527.

Cat. No. H07E-EN-01

**In the interest of product improvement, specifications are subject to change without notice.**

## OMRON EUROPE B.V.

Wegalaan 67-69,  
NL-2132 JD, Hoofddorp,  
The Netherlands  
Phone: +31 23 568 13 00  
Fax: +31 23 568 13 88  
www.industrial.omron.eu

10/2009